

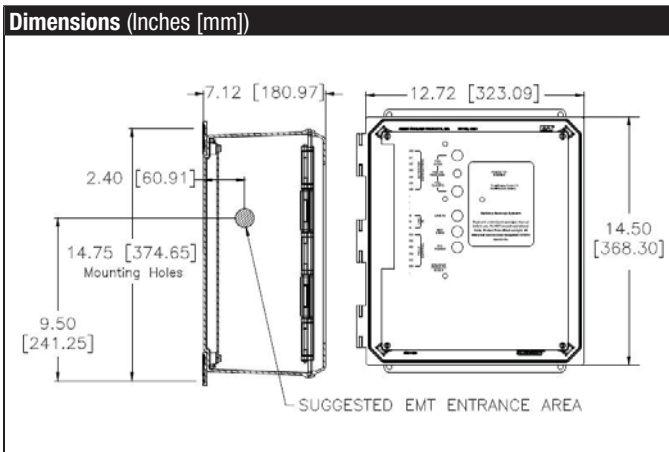

Technical Data	
Nominal Input Voltage	120 VAC
Mains Input Voltage Range	88-139 VAC
Input Frequency	50/60 Hz +/- 1 Hz (auto sensing)
Nominal Output Voltage	120 VAC
Power Capacity	350 VA / 210 Watts
Waveform Type	stepped approximation to a sine wave
Battery Typical Backup Time At Half-Load	5.6 minutes
Battery Type	Maintenance free sealed lead-acid
Battery Typical Recharge Time	Suspended electrolyte: Leak proof
Full Time Multi-Pole Noise Filtering	16 hours *
Ambient Temperature	5°F to 113°F [15°C to 45°C]
Storage Temperature	5°F to 113°F [15°C to 45°C]
APC Backup Module	cUL listed, FCC Part 15 Class B, FCC part 68, NOM, UL1778, UL497A, UL498

* The time to recharge to 90% of full battery capacity following a discharge to shutdown using a loaded rated for 1/2 of the full load rating of the UPS



Application

Typically, applications requiring fail-safe operation of actuated devices have had to rely on either the limited power of mechanical spring return actuators, or use costly high pressure pneumatic devices to provide fail-safe positioning. Model EXT-NSV series computer-grade UPS back-up systems designed for use with SY Series electric quarter-turn actuators provides the power necessary to drive these actuators to a field selectable fail-safe position. The system consists of a NEMA 4X steel key lock hinged door controls cabinet which houses the logic switching, all field wiring terminal points and a computer-grade back-up system. The back-up system is a component-level device which utilizes a replaceable spill-proof battery pack that can be readily purchased at most office-supply centers.

Operation

The back-up system is wired in series between the mains power and the actuator. Under normal operation, power supplied to the EXT-NSV will illuminate the green "LINE IN" indicator light, and provide charging voltage to the battery system. While under main power, the position of the "FAIL POSITION SELECT" switch is irrelevant. Power is supplied through the interface cabinet and the actuator heater is enabled. No current is being drawn from the battery system during this mode of operation. Optional indicator lights can be wired to show actuator end of travel status. These lamps are active as long as the battery system is running or Main power is present AND the actuator is receiving a signal to drive to the full OPEN or CLOSED position. Optional STATUS contacts can be used for remote health indicators of LINE voltage coming into the EXT-NSV and if the Battery System is operating.

When the mains power is lost, charging power is no longer supplied to the battery system. The green "LINE IN" indicator light is turned off, and the battery system automatically generates modified-sine wave line voltage to provide power for the actuator. The blue "BAT CHARGING" indicator light is turned off, and the yellow "B/U POWER" indicator light is turned on. The "FAIL POSITION SELECT" switch becomes active, and depending on its position, drives the actuator either fully open or fully closed. During this mode of operation, the position of any field interface switching is irrelevant. The battery system will provide ample power to drive the actuator more than 5 full torque cycles. However, once the actuator reaches its end-of-travel limit switch, power drain from the back-up system is reduced to the requirements of the yellow "B/U POWER" indicator light. After 15 minutes, the battery system turns itself off and waits for the mains power to return. The design provides automatic locking of the actuator position after the battery system shuts down. Normal operation is resumed when mains power returns.

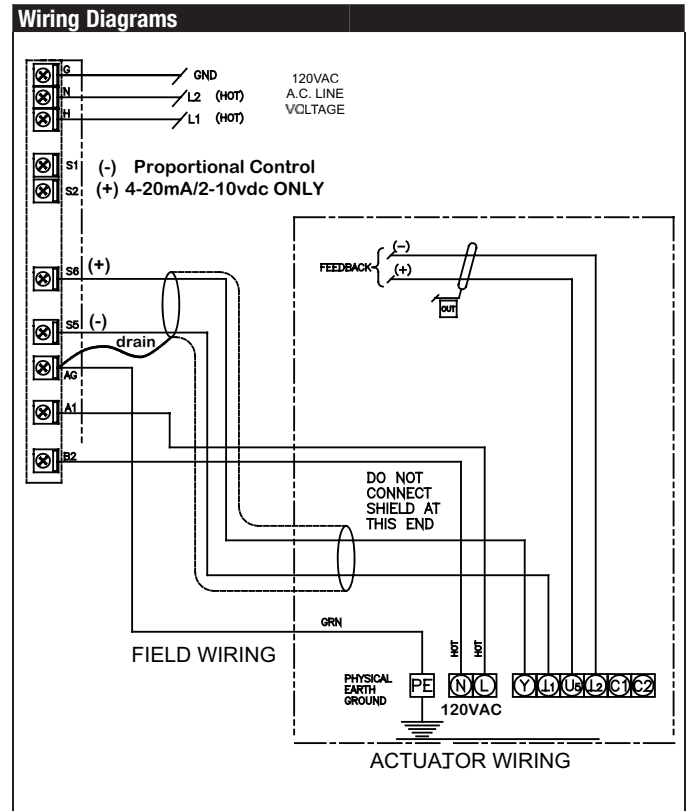

P10409 - 04/13 - Subject to change. © Belimo Aircontrols (USA), Inc.