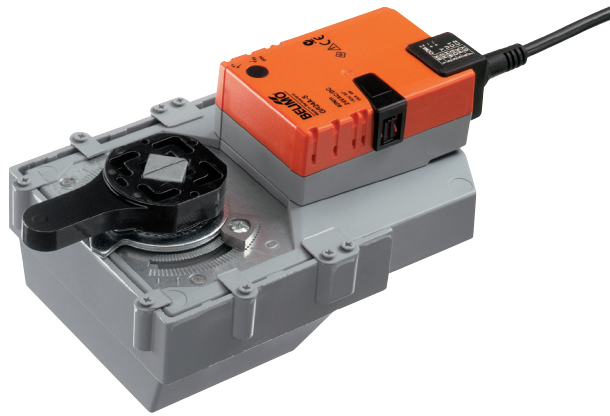

Rotary actuator for rotary valves and butterfly valves

- Torque motor 40 Nm
- Nominal voltage AC/DC 24 V
- Control modulating 2...10 V
- Position feedback 2...10 V

**Technical data**

<b>Electrical data</b>	Nominal voltage	AC/DC 24 V
	Nominal voltage frequency	50/60 Hz
	Nominal voltage range	AC 19.2...28.8 V / DC 19.2...28.8 V
	Power consumption in operation	4.5 W
	Power consumption in rest position	1.5 W
	Power consumption for wire sizing	6.5 VA
	Connection supply / control	Cable 1 m, 4 x 0.75 mm <sup>2</sup>
	Parallel operation	Yes (note the performance data)
<b>Functional data</b>	Torque motor	40 Nm
	Operating range Y	2...10 V
	Input Impedance	100 kΩ
	Position feedback U	2...10 V
	Position feedback U note	Max. 1 mA
	Position accuracy	±5%
	Manual override	with push-button, can be locked
	Running time motor	150 s / 90°
	Sound power level, motor	45 dB(A)
	Position indication	Mechanically, integrated, two-section
<b>Safety</b>	Protection class IEC/EN	III Safety Extra-Low Voltage (SELV)
	Protection class UL	UL Class 2 Supply
	Degree of protection IEC/EN	IP54
	Degree of protection NEMA/UL	NEMA 2
	Enclosure	UL Enclosure Type 2
	EMC	CE according to 2014/30/EU
	Certification IEC/EN	IEC/EN 60730-1 and IEC/EN 60730-2-14
	Certification UL	cULus according to UL60730-1A, UL60730-2-14 and CAN/CSA E60730-1:02
	Certification UL note	The UL marking on the actuator depends on the production site, the device is UL-compliant in any case
	Mode of operation	Type 1
	Rated impulse voltage supply / control	0.8 kV
	Control pollution degree	3
	Ambient temperature	-30...50 °C
Storage temperature	-40...80 °C	
Ambient humidity	Max. 95% r.H., non-condensing	
Servicing	maintenance-free	
<b>Mechanical data</b>	Connection flange	F05
	<b>Weight</b>	Weight
		2.4 kg

## Safety notes



- This device has been designed for use in stationary heating, ventilation and air-conditioning systems and must not be used outside the specified field of application, especially in aircraft or in any other airborne means of transport.
- Outdoor application: only possible in case that no (sea) water, snow, ice, insolation or aggressive gases interfere directly with the actuator and that is ensured that the ambient conditions remain at any time within the thresholds according to the data sheet.
- Only authorised specialists may carry out installation. All applicable legal or institutional installation regulations must be complied during installation.
- The switch for changing the direction of rotation may only be operated by authorised specialists. The direction of rotation must not in particular be reversed in a frost protection circuit.
- The device may only be opened at the manufacturer's site. It does not contain any parts that can be replaced or repaired by the user.
- Cables must not be removed from the device.
- The device contains electrical and electronic components and must not be disposed of as household refuse. All locally valid regulations and requirements must be observed.

## Product features

<b>Mode of operation</b>	The actuator is connected with a standard modulating signal of 0...10 V and drives to the position defined by the positioning signal. Measuring voltage U serves for the electrical display of the valve position 0.5...100% and as slave control signal for other actuators.
<b>Simple direct mounting</b>	Simple direct mounting on the rotary valve or butterfly valve with mounting flange. The mounting orientation in relation to the fitting can be selected in 90° steps.
<b>Manual override</b>	Manual override with push-button possible (the gear is disengaged for as long as the button is pressed or remains locked).
<b>Adjustable angle of rotation</b>	Adjustable angle of rotation with mechanical end stops.
<b>High functional reliability</b>	The actuator is overload protected, requires no limit switches and automatically stops when the end stop is reached.
<b>Combination valve/actuator</b>	For valves with the following mechanical specifications in accordance with ISO 5211 F05: - Square stem head SW = 14 mm for form-fit coupling of the rotary actuator. - Hole circle d = 50 mm

## Accessories

	Description	Type
<b>Electrical accessories</b>	Auxiliary switch 1 x SPDT add-on	S1A
	Auxiliary switch 2 x SPDT add-on	S2A
	Feedback potentiometer 140 Ω add-on	P140A
	Feedback potentiometer 200 Ω add-on	P200A
	Feedback potentiometer 500 Ω add-on	P500A
	Feedback potentiometer 1 kΩ add-on	P1000A
	Feedback potentiometer 2.8 kΩ add-on	P2800A
	Feedback potentiometer 5 kΩ add-on	P5000A
	Feedback potentiometer 10 kΩ add-on	P10000A

## Electrical installation



### Notes

- Connection via safety isolating transformer.
- Parallel connection of other actuators possible. Observe the performance data.
- Direction of rotation switch is covered. Factory setting: Direction of rotation Y2.

## Electrical installation

### Wiring diagrams

AC/DC 24 V, modulating

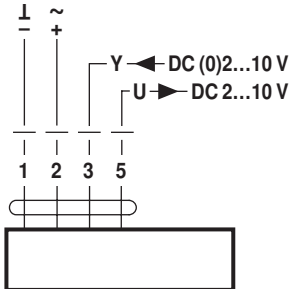



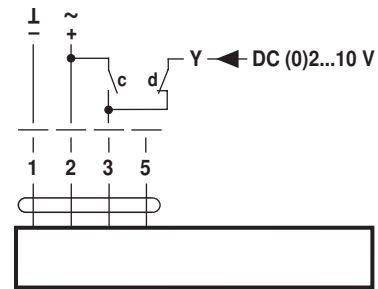



Override control (frost protection circuit)



#### Cable colours:

1 = black  
2 = red  
3 = white  
5 = orange

c	d	
		A - AB = 100%
		A - AB = 0%
		DC (0)2...10 V

## Dimensions [mm]

### Dimensional drawings

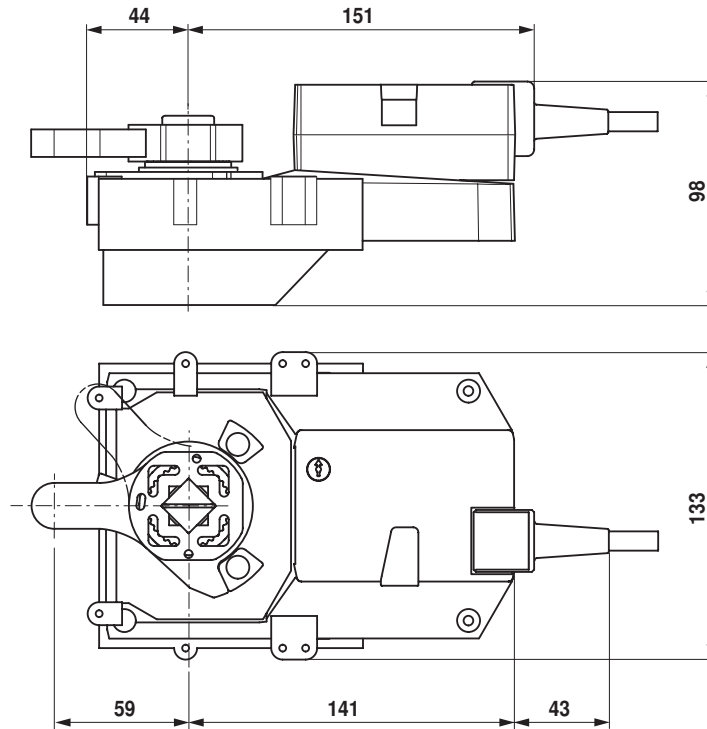

## Further documentation

- The complete product range for water applications
- Data sheets for rotary valves and butterfly valves
- Installation instructions for actuators and/or rotary valves and butterfly valves
- General notes for project planning