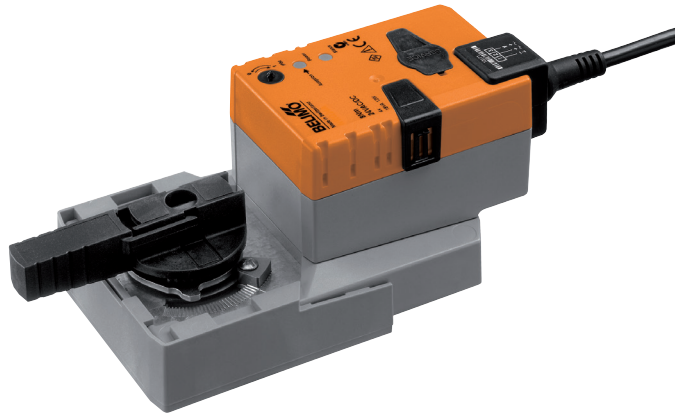

Modulating rotary actuator for ball valves

- Torque motor 8 Nm
- Nominal voltage AC/DC 24 V
- Control modulating 0.5...10 V
- Position feedback 0.5...10 V
- Running time motor 9 s

Technical data

Electrical data	Nominal voltage	AC/DC 24 V
	Nominal voltage frequency	50/60 Hz
	Nominal voltage range	AC 19.2...28.8 V / DC 19.2...28.8 V
	Power consumption in operation	13 W
	Power consumption in rest position	2 W
	Power consumption for wire sizing	23 VA
	Power consumption for wire sizing note	I _{max} 20 A @ 5 ms
	Connection supply / control	Cable 1 m, 4 x 0.75 mm ²
	Parallel operation	Yes (note the performance data)
Functional data	Torque motor	8 Nm
	Operating range Y	0.5...10 V
	Input Impedance	100 kΩ
	Position feedback U	0.5...10 V
	Position feedback U note	Max. 0.5 mA
	Position accuracy	±5%
	Manual override	with push-button, can be locked
	Running time motor	9 s / 90°
	Adaptation setting range	manual (automatic on first power-up)
	Sound power level, motor	52 dB(A)
	Position indication	Mechanically, pluggable
Safety	Protection class IEC/EN	III Safety Extra-Low Voltage (SELV)
	Protection class UL	UL Class 2 Supply
	Degree of protection IEC/EN	IP54
	Degree of protection NEMA/UL	NEMA 2
	Enclosure	UL Enclosure Type 2
	EMC	CE according to 2014/30/EU
	Certification IEC/EN	IEC/EN 60730-1 and IEC/EN 60730-2-14
	Certification UL	cULus according to UL60730-1A, UL60730-2-14 and CAN/CSA E60730-1:02
	Certification UL note	The UL marking on the actuator depends on the production site, the device is UL-compliant in any case
	Mode of operation	Type 1
	Rated impulse voltage supply / control	0.8 kV
	Control pollution degree	3
	Ambient temperature	-30...40 °C
	Ambient temperature note	Caution: +40...+50 °C utilisation possible only under certain restrictions. Please contact your supplier.
	Storage temperature	-40...80 °C
	Ambient humidity	Max. 95% r.H., non-condensing
	Servicing	maintenance-free
Weight	Weight	1.1 kg

Safety notes



- This device has been designed for use in stationary heating, ventilation and air-conditioning systems and must not be used outside the specified field of application, especially in aircraft or in any other airborne means of transport.
- Outdoor application: only possible in case that no (sea) water, snow, ice, insolation or aggressive gases interfere directly with the actuator and that is ensured that the ambient conditions remain at any time within the thresholds according to the data sheet.
- Only authorised specialists may carry out installation. All applicable legal or institutional installation regulations must be complied during installation.
- The switch for changing the direction of rotation may only be operated by authorised specialists. The direction of rotation must not in particular be reversed in a frost protection circuit.
- The device may only be opened at the manufacturer's site. It does not contain any parts that can be replaced or repaired by the user.
- Cables must not be removed from the device.
- Self adaption is necessary when the system is commissioned and after each adjustment of the angle of rotation (press the adaption push-button once).
- The device contains electrical and electronic components and must not be disposed of as household refuse. All locally valid regulations and requirements must be observed.

Product features

Mode of operation	The actuator is connected with a standard modulating signal of 0...10 V and drives to the position defined by the positioning signal. Measuring voltage U serves for the electrical display of the valve position 0.5...100% and as slave control signal for other actuators.
Simple direct mounting	Straightforward direct mounting on the ball valve with only one central screw. The assembly tool is integrated in the plug-in position indication. The mounting orientation in relation to the ball valve can be selected in 90° steps.
Manual override	Manual override with push-button possible (the gear is disengaged for as long as the button is pressed or remains locked).
Adjustable angle of rotation	Adjustable angle of rotation with mechanical end stops.
High functional reliability	The actuator is overload protected, requires no limit switches and automatically stops when the end stop is reached.
Home position	The first time the supply voltage is switched on, i.e. at the time of commissioning, the actuator carries out an adaption, which is when the operating range and position feedback adjust themselves to the mechanical setting range. The detection of the mechanical end stops enables a gentle approach to the end positions, thus protecting the actuator mechanics. The actuator then moves into the position defined by the positioning signal. Factory setting: Y2 (counter-clockwise rotation).
Adaption and synchronisation	An adaption can be triggered manually by pressing the "Adaption" button. Both mechanical end stops are detected during the adaption (entire setting range). Automatic synchronisation after pressing the gear disengagement button is configured. The synchronisation is in the home position (0%). The actuator then moves into the position defined by the positioning signal.

Accessories

Electrical accessories	Description	Type
	Auxiliary switch 1 x SPDT add-on	S1A
	Auxiliary switch 2 x SPDT add-on	S2A
	Feedback potentiometer 140 Ω add-on	P140A
	Feedback potentiometer 200 Ω add-on	P200A
	Feedback potentiometer 500 Ω add-on	P500A
	Feedback potentiometer 1 kΩ add-on	P1000A
	Feedback potentiometer 2.8 kΩ add-on	P2800A
	Feedback potentiometer 5 kΩ add-on	P5000A
	Feedback potentiometer 10 kΩ add-on	P10000A

Electrical installation

Notes

- Connection via safety isolating transformer.
- Parallel connection of other actuators possible. Observe the performance data.
- Direction of rotation switch is covered. Factory setting: Direction of rotation Y2.

Wiring diagrams

AC/DC 24 V, modulating

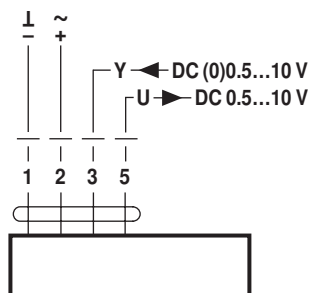

Cable colours:
 1 = black
 2 = red
 3 = white
 5 = orange

Override control (frost protection circuit)

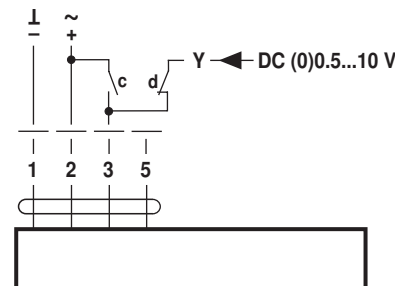

c	d	
		A - AB = 100%
		A - AB = 0%
		DC (0)0.5...10 V

Signal cable lengths

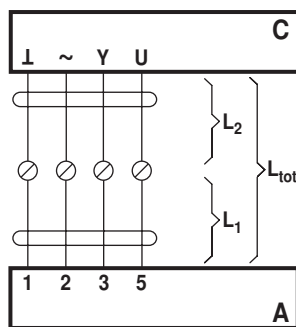

L ₂ I / ~	L _{tot} = L ₁ + L ₂	
	AC	DC
0.75 mm ²	≤30 m	≤5 m
1.00 mm ²	≤40 m	≤8 m
1.50 mm ²	≤70 m	≤12 m
2.50 mm ²	≤100 m	≤20 m

A = Actuator
 C = Control unit (controlling unit)
 L1 = Connecting cable of the actuator
 L2 = Customer cable
 Ltot = Maximum signal cable length

Note:
 When several actuators are connected in parallel, the maximum signal cable length must be divided by the number of actuators.

Operating controls and indicators

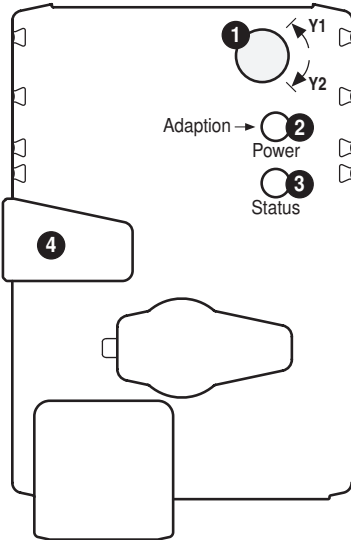

1 Direction of rotation switch

Switch over: Direction of rotation changes

2 Push-button and LED display green

Off: No power supply or malfunction

On: In operation

Press button: Triggers angle of rotation adaptation, followed by standard mode

3 Push-button and LED display yellow

Off: Standard mode

On: Adaptation or synchronising process active

Press button: No function

4 Gear disengagement button

Press button: Gear disengages, motor stops, manual override possible

Release button: Gear engages, synchronisation starts, followed by standard mode

Check power supply connection

2 Off and 3 On Possible wiring error in power supply

Dimensions [mm]

Dimensional drawings

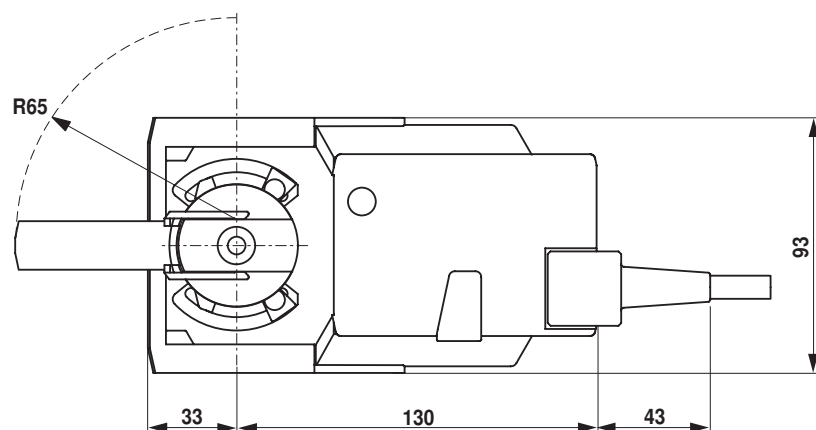
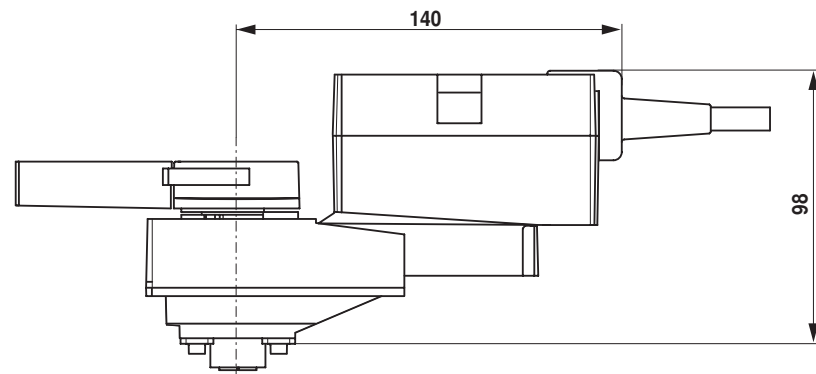

Further documentation

- The complete product range for water applications
- Data sheets for ball valves
- Installation instructions for actuators and/or ball valves
- General notes for project planning