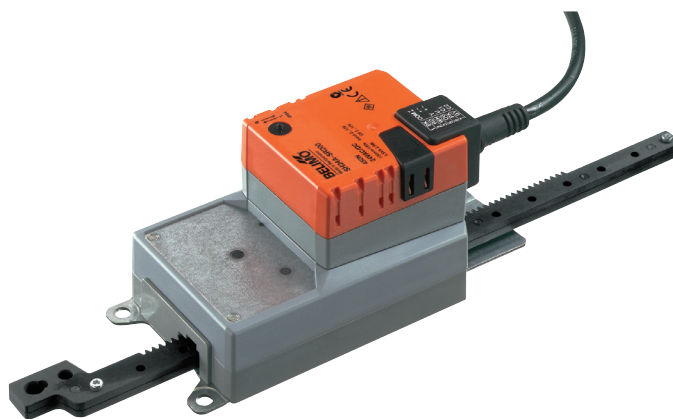

Modulating linear actuator for adjusting dampers and slide valves in technical building equipment

- Air damper size up to approx. 3 m²
- Actuating force 450 N
- Nominal voltage AC/DC 24 V
- Control modulating 2...10 V
- Position feedback 2...10 V
- Length of Stroke Max. 200 mm, fixed setting

Technical data

Electrical data	Nominal voltage	AC/DC 24 V
	Nominal voltage frequency	50/60 Hz
	Nominal voltage range	AC 19.2...28.8 V / DC 19.2...28.8 V
	Power consumption in operation	2.5 W
	Power consumption in rest position	0.4 W
	Power consumption for wire sizing	4.5 VA
	Connection supply / control	Cable 1 m, 4 x 0.75 mm ²
	Parallel operation	Yes (note the performance data)
Functional data	Actuating force motor	450 N
	Operating range Y	2...10 V
	Input Impedance	100 kΩ
	Position feedback U	2...10 V
	Position feedback U note	Max. 1 mA
	Position accuracy	±5%
	Direction of motion motor	selectable with switch
	Direction of motion note	Y = 0 V: with switch 0 (extended) / 1 (retracted)
	Manual override	with push-button, can be locked
	Stroke	200 mm
	Length of Stroke	Max. 200 mm, fixed setting
	Running time motor	150 s / 100 mm
	Sound power level, motor	52 dB(A)
Safety	Protection class IEC/EN	III Safety Extra-Low Voltage (SELV)
	Protection class UL	UL Class 2 Supply
	Degree of protection IEC/EN	IP54
	Degree of protection NEMA/UL	NEMA 2
	Enclosure	UL Enclosure Type 2
	EMC	CE according to 2014/30/EU
	Certification IEC/EN	IEC/EN 60730-1 and IEC/EN 60730-2-14
	Certification UL	cULus according to UL60730-1A, UL60730-2-14 and CAN/CSA E60730-1:02
	Certification UL note	The UL marking on the actuator depends on the production site, the device is UL-compliant in any case
	Mode of operation	Type 1
	Rated impulse voltage supply / control	0.8 kV
	Control pollution degree	3
	Ambient temperature	-30...50 °C
Storage temperature	-40...80 °C	
Ambient humidity	Max. 95% r.H., non-condensing	
Servicing	maintenance-free	
Weight	Weight	1.2 kg

Safety notes



- The device must not be used outside the specified field of application, especially not in aircraft or in any other airborne means of transport.
- Outdoor application: only possible in case that no (sea) water, snow, ice, insolation or aggressive gases interfere directly with the actuator and that is ensured that the ambient conditions remain at any time within the thresholds according to the data sheet.
- Only authorised specialists may carry out installation. All applicable legal or institutional installation regulations must be complied during installation.
- The device may only be opened at the manufacturer's site. It does not contain any parts that can be replaced or repaired by the user.
- Cables must not be removed from the device.
- The gear rod and the mechanical end stops must not be removed.
- The rotary supports and coupling pieces available as accessories and must always be used if transverse forces are likely. In addition, the actuator must not be tightly bolted to the application. It must remain movable via the rotary support (refer to «Assembly notes»).
- If the actuator is exposed to severely contaminated ambient air, appropriate precautions must be taken on the system side. Excessive deposits of dust, soot etc. can prevent the gear rod from being extended and retracted correctly.
- If not installed horizontally, the gear disengagement push-button may only be actuated when there is no pressure on the gear rod.
- To calculate the actuating force required for air dampers and slide valves, the specifications supplied by the damper manufacturers concerning the cross section, the design, the installation site and the ventilation conditions must be observed.
- If a rotary support and/or coupling piece is used, actuation force losses are to be expected.
- The device contains electrical and electronic components and must not be disposed of as household refuse. All locally valid regulations and requirements must be observed.

Product features

Mode of operation	The actuator is connected with a standard modulating signal of 0...10 V and drives to the position defined by the positioning signal. Measuring voltage U serves for the electrical display of the damper position 0.5...100% and as slave control signal for other actuators.
Simple direct mounting	The actuator can be directly connected with the application using the enclosed screws. The head of the gear rod is connected to the moving part of the ventilating application individually on the mounting side or with the Z-KS1 coupling piece provided for this purpose.
Manual override	Manual override with push-button possible (the gear is disengaged for as long as the button is pressed or remains locked).
High functional reliability	The actuator is overload protected, requires no limit switches and automatically stops when the end stop is reached.

Accessories

	Description	Type
Electrical accessories	Range controller for wall mounting	SBG24
	Positioner for wall mounting	SGA24
	Positioner for built-in mounting	SGE24
	Positioner for front-panel mounting	SGF24
	Positioner for wall mounting	CRP24-B1
Mechanical accessories	Description	Type
	End stop kit, Multipack 20 pcs.	Z-AS1
	Rotary support, for linear actuator	Z-DS1
	Coupling piece M8	Z-KS1

Electrical installation



Notes

- Connection via safety isolating transformer.
- Parallel connection of other actuators possible. Observe the performance data.

Wiring diagrams

AC/DC 24 V, modulating

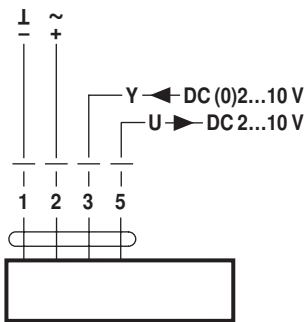

Installation notes



Notes

- If a rotary support and/or coupling piece is used, losses in the actuation force losses are to be expected.

Applications without transverse force

The linear actuator is screwed directly to the housing at three points. Afterwards, the head of the gear rod is fastened to the moving part of the ventilation application (e.g. damper or slide valve).

Applications with transverse forces

The coupling piece with the internal thread (Z-KS1) is connected to the head of the gear rod. The rotary support (Z-DS1) is screwed to the ventilation application. Afterwards, the linear actuator is screwed to the previously mounted rotary support with the enclosed screw. Afterwards, the coupling piece, which is mounted to the head of the gear rod, is attached to the moving part of the ventilating application (e.g. damper or slide valve). The transverse forces can be compensated for to a certain limit with the rotary support and/or coupling piece. The maximum permissible swivel angle of the rotary support and coupling piece is 10° (angle), laterally and upwards.

Dimensions [mm]

Dimensional drawings

