

Rotary actuator with fail-safe for ball valves

- Torque motor 20 Nm
- Nominal voltage AC/DC 24 V
- Control Open/close
- Deenergised closed (NC)
- with 2 integrated auxiliary switches

**Technical data**

<b>Electrical data</b>	Nominal voltage	AC/DC 24 V
	Nominal voltage frequency	50/60 Hz
	Nominal voltage range	AC 19.2...28.8 V / DC 21.6...28.8 V
	Power consumption in operation	5 W
	Power consumption in rest position	2.5 W
	Power consumption for wire sizing	7.5 VA
	Auxiliary switch	2 x SPDT, 1 x 10% / 1 x 11...90%
	Switching capacity auxiliary switch	1 mA...3 A (0.5 A inductive), AC 250 V
	Connection supply / control	Cable 1 m, 2 x 0.75 mm <sup>2</sup>
	Connection auxiliary switch	Cable 1 m, 6 x 0.75 mm <sup>2</sup>
	Parallel operation	Yes (note the performance data)
	<b>Functional data</b>	Torque motor
Torque fail-safe		20 Nm
Direction of motion fail-safe		Deenergised NC, valve closed (A – AB = 0%)
Manual override		by means of hand crank and locking switch
Running time motor		75 s / 90°
Running time fail-safe		<20 s / 90°
Running time fail-safe note		@ -20...50°C / <60 s @ -30°C
Sound power level, motor		45 dB(A)
Position indication		Mechanical
Service life		Min. 60'000 fail-safe positions
<b>Safety</b>	Protection class IEC/EN	III Safety Extra-Low Voltage (SELV)
	Protection class UL	UL Class 2 Supply
	Protection class auxiliary switch IEC/EN	II reinforced insulation
	Degree of protection IEC/EN	IP54
	Degree of protection NEMA/UL	NEMA 2
	Enclosure	UL Enclosure Type 2
	EMC	CE according to 2014/30/EU
	Low voltage directive	CE according to 2014/35/EU
	Certification IEC/EN	IEC/EN 60730-1 and IEC/EN 60730-2-14
	Certification UL	cULus according to UL60730-1A, UL60730-2-14 and CAN/CSA E60730-1:02
	Certification UL note	The UL marking on the actuator depends on the production site, the device is UL-compliant in any case
	Mode of operation	Type 1.AA.B
	Rated impulse voltage supply / control	0.8 kV
	Rated impulse voltage auxiliary switch	2.5 kV
	Control pollution degree	3
Ambient temperature	-30...50°C	
Storage temperature	-40...80°C	
Ambient humidity	Max. 95% r.H., non-condensing	
Servicing	maintenance-free	
<b>Weight</b>	Weight	2.3 kg

Safety notes



- This device has been designed for use in stationary heating, ventilation and air-conditioning systems and must not be used outside the specified field of application, especially in aircraft or in any other airborne means of transport.
- Outdoor application: only possible in case that no (sea) water, snow, ice, insolation or aggressive gases interfere directly with the actuator and that is ensured that the ambient conditions remain at any time within the thresholds according to the data sheet.
- Only authorised specialists may carry out installation. All applicable legal or institutional installation regulations must be complied during installation.
- The device may only be opened at the manufacturer's site. It does not contain any parts that can be replaced or repaired by the user.
- Cables must not be removed from the device.
- The device contains electrical and electronic components and must not be disposed of as household refuse. All locally valid regulations and requirements must be observed.
- The two switches integrated in the actuator are to be operated either on power supply voltage or at safety extra-low voltage. The combination power supply voltage/ safety extra-low voltage is not permitted.

Product features

<b>Mode of operation</b>	The actuator moves the valve to the operating position at the same time as tensioning the return spring. The valve is turned back to the fail-safe position by spring force when the supply voltage is interrupted.
<b>Simple direct mounting</b>	Simple direct mounting on the ball valve with only one screw. The mounting orientation in relation to the ball valve can be selected in 90° steps.
<b>Manual override</b>	By using the hand crank the valve can be operated manually and engaged with the locking switch at any position. Unlocking is carried out manually or automatically by applying the operating voltage.
<b>Adjustable angle of rotation</b>	Adjustable angle of rotation with mechanical end stops.
<b>High functional reliability</b>	The actuator is overload protected, requires no limit switches and automatically stops when the end stop is reached.
<b>Flexible signalization</b>	The actuator has one auxiliary switch with a fixed setting and one adjustable auxiliary switch. They permit a 10% or 11...90% angle of rotation to be signaled.

Electrical installation



Notes

- Connection via safety isolating transformer.
- Parallel connection of other actuators possible. Observe the performance data.

Wiring diagrams

AC/DC 24 V, open/close

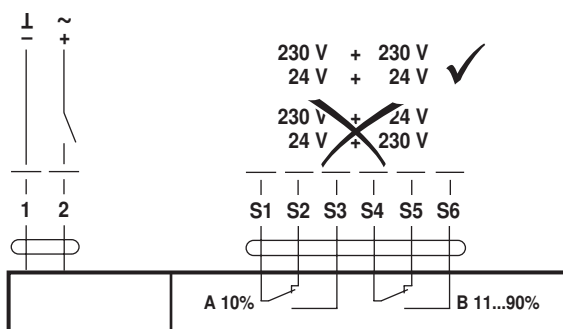

Cable colours:

- 1 = black
- 2 = red
- S1 = violet
- S2 = red
- S3 = white
- S4 = orange
- S5 = pink
- S6 = grey

## Operating controls and indicators

### Auxiliary switch settings

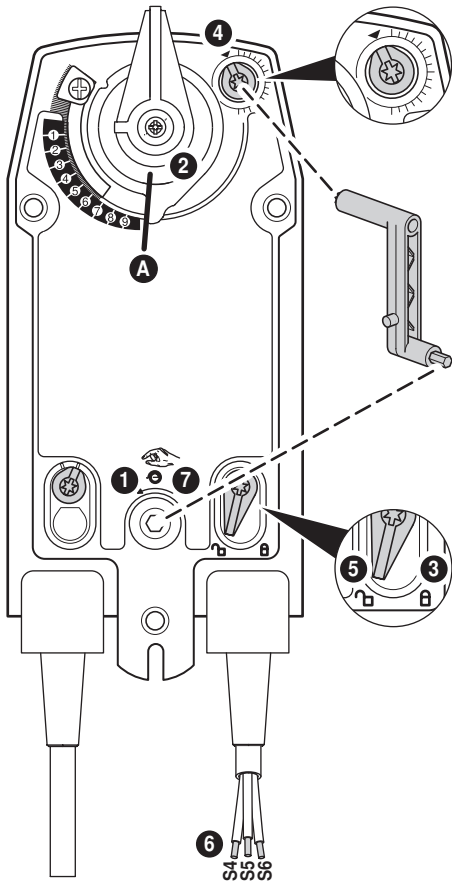

**Note:** Perform settings on the actuator only in deenergised state.

- 1 Manual override**  
Turn the hand crank until the desired switching position is set.
- 2 Spindle clamp**  
Edge line **A** displays the desired switching position of the actuator on the scale.
- 3 Fasten the locking device**  
Turn the locking switch to the „Locked padlock“ symbol.
- 4 Auxiliary switch**  
Turn rotary knob until the notch points to the arrow symbol.
- 5 Unlock the locking device**  
Turn the locking switch to the „Unlocked padlock“ symbol or unlock with the hand crank.
- 6 Cable**  
Connect continuity tester to S4 + S5 or to S4 + S6.
- 7 Manual override**  
Turn the hand crank until the desired switching position is set and check whether the continuity tester shows the switching point.

## Dimensions [mm]

## Dimensional drawings

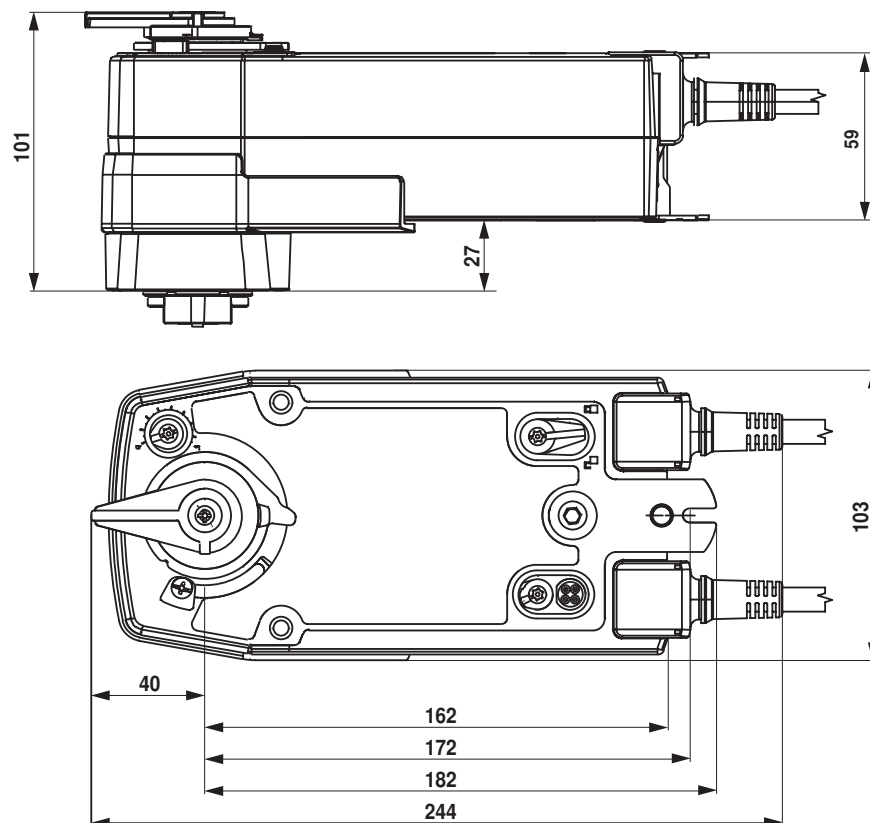

## Further documentation

- The complete product range for water applications
- Data sheets for ball valves
- Installation instructions for actuators and/or ball valves
- General notes for project planning