

- Actuating force 1500 N
- Nominal voltage AC 100...240 V
- Control Open/close, 3-point
- Stroke 20 mm



Technical data

Electrical data	Nominal voltage	AC 100...240 V
	Nominal voltage frequency	50/60 Hz
	Nominal voltage range	AC 85...264 V
	Power consumption in operation	2 W
	Power consumption in rest position	1 W
	Power consumption for wire sizing	4 VA
	Connection supply / control	Terminals 4 mm ² (cable Ø4...10 mm)
	Parallel operation	Yes (note the performance data)
Functional data	Actuating force motor	1500 N
	Manual override	with push-button, can be locked
	Stroke	20 mm
	Running time motor	35 s / 20 mm
	Sound power level, motor	60 dB(A)
	Position indication	Mechanically, 5...20 mm stroke
Safety data	Protection class IEC/EN	II reinforced insulation
	Protection class UL	UL Class 2 Supply
	Degree of protection IEC/EN	IP54
	Degree of protection NEMA/UL	NEMA 2 UL Enclosure Type 2
	EMC	CE according to 2014/30/EU
	Low voltage directive	CE according to 2014/35/EU
	Certification IEC/EN	IEC/EN 60730-1 and IEC/EN 60730-2-14
	Certification UL	cULus according to UL60730-1A, UL60730-2-14 and CAN/CSA E60730-1:02 The UL marking on the actuator depends on the production site, the device is UL-compliant in any case
	Mode of operation	Type 1
	Rated impulse voltage supply / control	4 kV
	Control pollution degree	3
	Ambient temperature	0...50°C
	Storage temperature	-40...80°C
	Ambient humidity	Max. 95% r.H., non-condensing
Servicing	maintenance-free	
Weight	Weight	2.6 kg

Safety notes



- This device has been designed for use in stationary heating, ventilation and air-conditioning systems and must not be used outside the specified field of application, especially in aircraft or in any other airborne means of transport.
- Outdoor application: only possible in case that no (sea) water, snow, ice, insolation or aggressive gases interfere directly with the device and that it is ensured that the ambient conditions remain within the thresholds according to the data sheet at any time.
- Only authorised specialists may carry out installation. All applicable legal or institutional installation regulations must be complied during installation.
- The switch for changing the direction of motion and so the closing point may be adjusted only by authorised specialists. The direction of motion is critical, particularly in connection with frost protection circuits.
- The device may only be opened at the manufacturer's site. It does not contain any parts that can be replaced or repaired by the user.
- The device contains electrical and electronic components and must not be disposed of as household refuse. All locally valid regulations and requirements must be observed.

Product features

Mounting on third-party valves	The retrofit actuators for installation on a wide range of valves from various manufacturers are comprised of an actuator, bracket, universal valve neck adapter and universal valve stem adapter. Adapt the valve neck and valve stem to begin with, then attach the retrofit bracket to the valve neck adapter. Now fit the retrofit actuator into the bracket and connect it to the valve. Whilst taking the position of the valve closing point into account, secure the actuator to the bracket and then conduct the commissioning process. The valve neck adapter/actuator can be rotated through 360° on the valve neck, provided it is permitted by the size of the installed valve.
Mounting on Belimo valves	Use standard actuators from Belimo for mounting on Belimo globe valves. The installation of retrofit actuators on Belimo globe valves is technically possible.
Manual override	Manual override with push-button possible (the gear is disengaged for as long as the button is pressed or remains locked). The stroke can be adjusted by using a hexagon socket screw key (4 mm), which is inserted into the top of the actuator. The stroke shaft extends when the key is rotated clockwise.
High functional reliability	The actuator is overload protected, requires no limit switches and automatically stops when the end stop is reached.
Position indication	The stroke is indicated mechanically on the bracket with tabs. The stroke range adjusts itself automatically during operation.
Home position	Factory setting: Actuator spindle is retracted.
Setting direction of stroke	When actuated, the stroke direction switch changes the running direction in normal operation.
Restriction 3-point controller	It must be ensured that the pulsating 3-point controller stops when the end position is reached. If this is not possible on the system side, the multifunctional 24 V version of the actuator (..V24A-MP-..) must be used.

Accessories

Electrical accessories	Description	Type
	Auxiliary switch 2 x SPDT add-on	S2A-H
Mechanical accessories	Description	Type
	Spacer ring for LDM, stroke 20 mm	ZNV-203
	Spacer ring for Sauter, stroke 20 mm	ZNV-204
	Adapter kit Danfoss	ZNV-205

Electrical installation



Caution: Power supply voltage!
Parallel connection of other actuators possible. Observe the performance data.
Direction of stroke switch factory setting: Actuator spindle retracted (▲).

Wiring diagrams

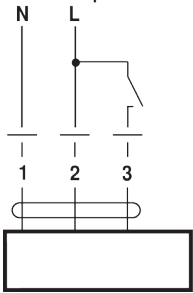
AC 230 V, open/close

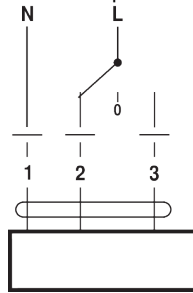

AC 230 V, 3-point



Operating controls and indicators

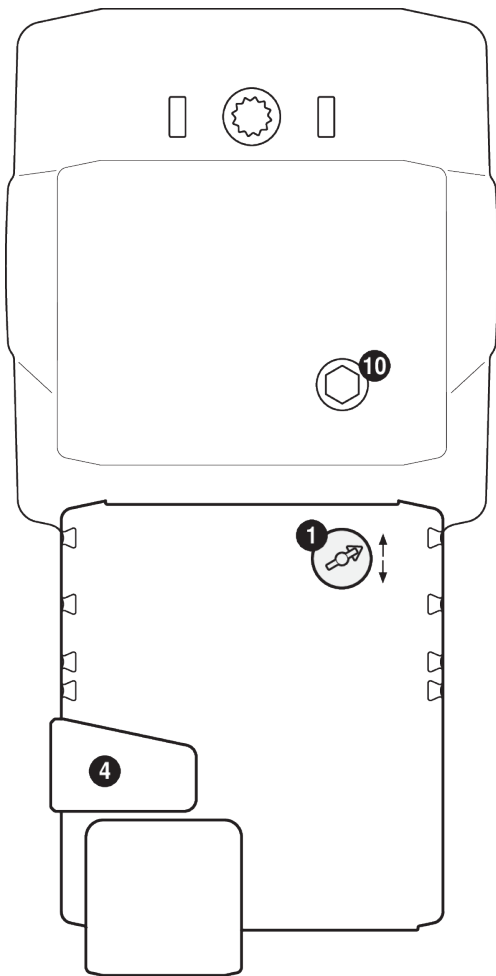

1 Direction of stroke switch

Switch over: Direction of stroke changes

4 Gear disengagement button

Press button: Gear disengages, motor stops, manual override possible

Release button: Gear engages, standard mode

10 Manual override

Clockwise: Actuator spindle extends

Counterclockwise: Actuator spindle retracts

Dimensions

Dimensional drawings

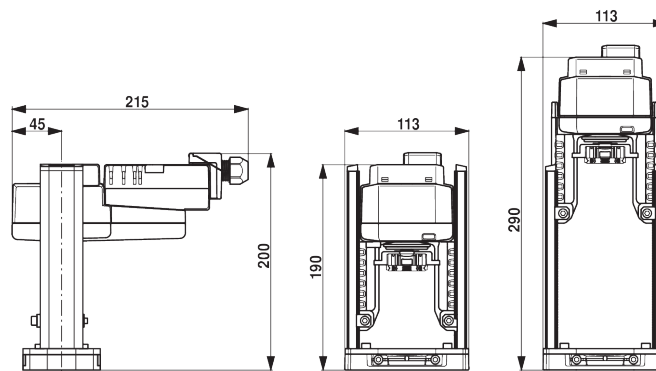

Further documentation

- Installation instructions for actuators