

- Torque 2 Nm /
- Nominal voltage AC 120 V
- Control On/Off



5-year warranty



### Technical data

<b>Electrical data</b>	Nominal voltage	AC 120 V
	Nominal voltage frequency	50/60 Hz
	Power consumption in operation	2 W, 3.5 VA
	Power consumption in rest position	1.5 W, 2.5 VA
	Auxiliary switch	2 x SPST, 3 A resistive (0.5 A inductive) @ AC 250 V, one set at 10°, one set at 80°
	Switching capacity auxiliary switch	3 A resistive (0.5 A inductive) @ AC 250 V
	Electrical Connection	(2) 18 GA appliance cables with 1/2" conduit connectors, 3 ft [1 m],
	Overload Protection	electronic throughout 0...95° rotation
	Electrical Protection	actuators are double insulated
<b>Functional data</b>	Torque motor	18 in-lb [2 Nm]
	Direction of motion motor	selectable by ccw/cw mounting
	Direction of motion fail-safe	reversible with cw/ccw mounting
	Angle of rotation	95°
	Running Time (Motor)	75 s / 90°
	Running time motor note	@ 250°F [121°C]
	Running time fail-safe	<25 s @ 32...122°F [0...50°C]
	Noise level, motor	45 dB(A)
	Noise level, fail-safe	62 dB(A)
	Shaft Diameter	1/4...1/2" round, centers on 1/2"
Position indication	Mechanical	
<b>Safety data</b>	Degree of protection IEC/EN	IP42
	Degree of protection NEMA/UL	NEMA 2
	Enclosure	UL Enclosure Type 2
	Agency Listing	cULus acc. to UL60730-1A/-2-14, CAN/CSA E60730-1:02, Listed to UL 2043 - suitable for use in air plenums per Section 300.22(C) of the NEC and Section 602 of the IMC. California State Fire Marshal Listing 3210-1593:104
	Quality Standard	ISO 9001
	Ambient temperature	32...122°F [0...50°C]
	Storage temperature	-40...176°F [-40...80°C]
	Ambient humidity	Max. 95% RH, non-condensing
	Servicing	maintenance-free
	<b>Weight</b>	Weight
<b>Materials</b>	Housing material	UL94-5VA

**Footnotes** Part no. Clamp side spring-return  
 FSTF120 US CW  
 FSTF120.1 US CW (bulk pack)  
 FSTF120.1 CCW CCW (bulk pack)  
 FSTF120-S US CW CW  
 FSTF120-S.1 US CW (bulk pack)  
 FSTF120-S.1 CCW CCW (bulk pack)  
 FSTF24-S.1 US CW (bulk pack)  
 † UL File XAPX.E108966

**Safety notes**

- Screw a conduit fitting into the actuator's bushing. Jacket the actuator's input and output wiring with suitable flexible conduit. Properly terminate the conduit in a suitable junction box.
- Retrofit Safety Note
- Use of the FSTF for replacement of other makes of actuators is limited in damper area. The FSLF is preferred for direct coupled applications. The FSTF may be applied for linkage applications on dampers 1.5 sq.ft. and smaller at velocities under 2000 fpm.

**Product features**



- Application** The FS series of spring-return actuators are designed for the operation of UL555 and UL555S listed fire/smoke dampers in ventilation and air-conditioning systems.
- Operation** The actuator is mounted in its fail safe position with the damper blade(s) typically closed. Upon applying power, the actuator drives the damper to the open position. The internal spring is tensioned at the same time. If the power supply is interrupted, the spring moves the damper back to its fail-safe position.
- Typical specification** All smoke and combination fire and smoke dampers shall be provided with Belimo FSTF, FSLF, FSNF, or FSAF series actuators. All substitutions must be approved before submission of bid. Damper and actuator shall have UL555S Listing for 250°F and/or 350°F. Actuator shall have been tested to UL2043 per requirements of IMC 602.2 and NEC 300.22 (c). Where position indication is required -S models with auxiliary switches shall be provided.

**Accessories**

Electrical accessories	Description	Type
	Thermoelectric tripping device, Duct inside temperature 165°F	BAE165 US
Mechanical accessories	Description	Type
	Position indicator for TFB(X)	IND-TF
	Ball joint suitable for damper crank arm KH8, Multipack 10 pcs.	KG8
	TFB(X) crankarm with 5/16" slot.	KH-TF US
	TFB(X) crankarm with 1/4" slot.	KH-TF-1 US
	Anti-rotation bracket TF/NKQ/AM/NM/LM.	TF-P
	Wrench 0.32 in and 0.39 in [8 mm and 10 mm]	TOOL-06
	Angle of rotation limiter, with end stop	ZDB-TF
	TFB(X) crankarm adaptor kit (T bracket included).	ZG-TF2
	Mounting kit for TFB(X)	ZG-TF3
	TFB(X) crankarm adaptor kit (includes ZG-113).	ZG-TF112
	Weather shield 330x203x152 mm [13x8x6"] (LxBxH)	ZS-100
	Weather shield 406x213x102 mm [16x8-3/8x4"] (LxWxH)	ZS-150

**Electrical installation**

- Provide overload protection and disconnect as required.
- Actuators may be powered in parallel. Power consumption must be observed.
- S4 makes to S6 when actuator is powered open.
- Auxiliary switches are for end position indication or interlock control.
- Double insulated.

 Ground present on some models.  
 Meets cULus requirements without the need of an electrical ground connection.

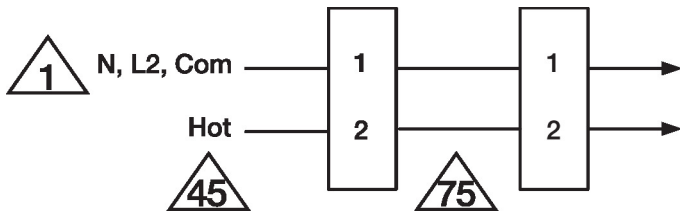

Parallel Actuator Wiring

**Wiring diagrams**

AC 120 V

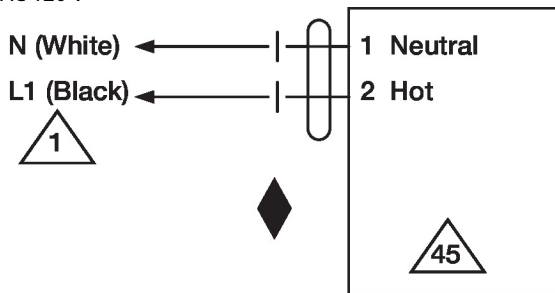

Typical containment damper control wiring  
 Detector or relay F&S Damper

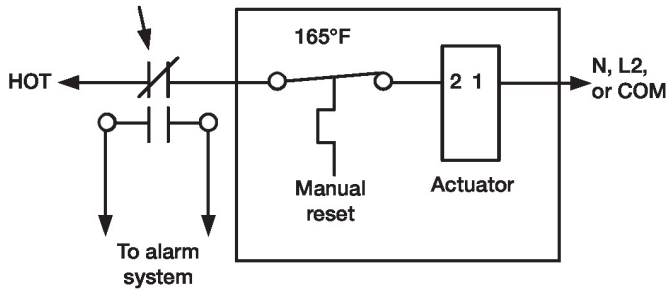

Parallel Actuator Wiring

Auxiliary Switch

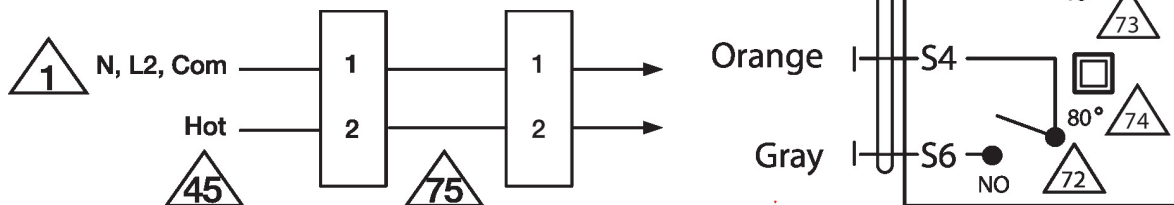

Dimensions

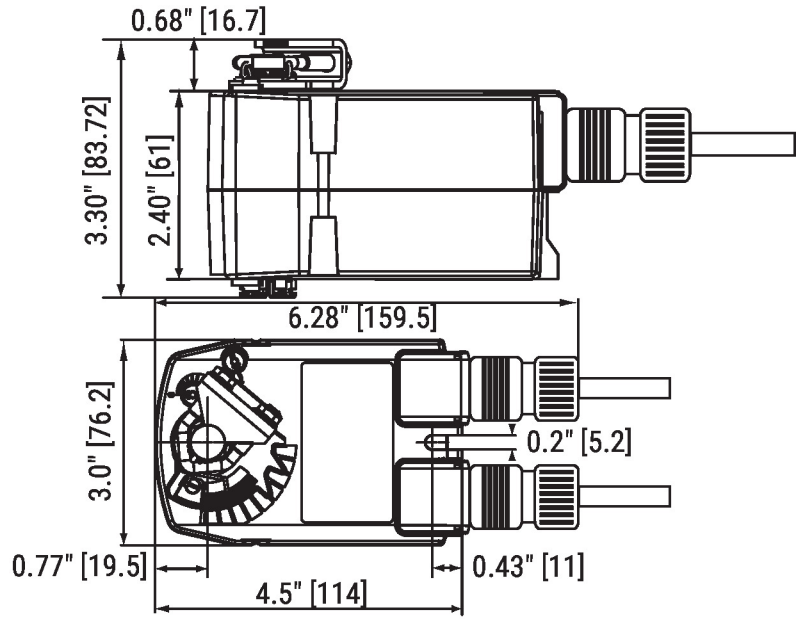

Standard:

∅ 1/4" to 1/2"

□ 1/4" to 5/16"