

CHALLENGER – Headquarters of Bouygues Construction

World's first: Building renovation to receive triple certification



This exemplary renovation is part of Bouygues Construction's determined pursuit of a strategy with the goal of becoming world leader in the area of sustainable building. The Group has been systematically implementing ecological design and environmental concepts in its projects since 2007. Bouygues, together with the Group subsidiary Bouygues Energies & Services, is eminently positioned, particularly with regard to optimisation of the energy consumption in new buildings and in those in need of renovation.

The Challenger site in the Parisian suburb of Guyancourt is to date unique in the world with respect to sustainable building renovation. In 2014, the French construction group Bouygues will have renovated all of its headquarter buildings, which was built in 1988 and has a total area of 67,000 m², in accordance with the most stringent of environmental and energy efficiency specifications. The consumption of primary energy and water will be reduced thereby to 10% and 40%, respectively, of their original values.

Bouygues Construction heads many thousand construction projects worldwide and employs 55,400 individuals in 80 countries. The kick-off of the renovation work on the company's own headquarters took place in 2010 with the Triangle South and North buildings. After their completion in August 2012,

the North and South West wings of the main building were next in line; they were completed in 2013. Challenger has in the meantime received the top awards of the three leading international certification bodies in the area of sustainability for its outstanding energy balance.

The goal: Triple certification

Building type:	Office building
Project type:	Renovation
Trade:	HVAC
Belimo products:	50 Belimo Energy Valve™
Commissioning:	2011 – 2014 (planned)

Energy Valve controls flow of cooling water

Bouygues defined this triple certification as an objective of the project at the time of planning in 2008. In order to achieve this goal, the Group's research and development teams developed numerous innovations in cooperation with the industry. Among other things, an innovative air conditioning system with variable refrigerant flow (VRF) was developed. The Belimo Energy Valve™ has a central role to play in the project. Depending on the temperature requirements of the VRF, a Delta T minimum value is set through the web browser integrated in the valve which is then measured continuously using temperature sensors in the supply and return lines. An additional sensor simultaneously measures the volumetric flow values for the energy calculation. The valve now controls the volumetric flow to ensure that the Delta T value does not fall below the minimum value. The building technology control centre is informed at all times by this energy monitoring as to whether the cooling equipment is working efficiently and can intervene in a controlling capacity if necessary.

Top marks through innovation

The Bouygues Headquarters Challenger is thus the first renovation object in the world that can claim triple certification for the



environmental and energy efficiency concepts that it has implemented. The first wing to be renovated received the certifications with top marks in 2012: "Platinum"(LEED®), "Outstanding"(BREEAM®) and "Exceptional"(HQE®). The site's excellent environmental balance thus meets the strictest of international standards.

Certification is granted solely to projects that pursue a comprehensive approach that proceeds from project planning through construction all the way to building operation. Positive evaluation was also extended, for example, for the installation of 21,500 m² of photovoltaic modules and 420 m² of solar energy collectors, in addition to the 75 geothermal probes. In addition, a phyto-purification plant is used to reprocess the entirety of the area's waste water and rain water.

The certifications



The American building certification system LEED® (Leadership in Environmental & Energy Design) is oriented to the standards of the ASHRAE (American Society of Heating, Refrigerating and Air-Conditioning Engineers) for analysing the entire energy consumption of the building. It places emphasis on the improvement of indoor air quality through the use of materials, reduction of dust emissions and air quality testing. Thus, for example, 20 percent of the materials must have a high recycling content and originate from areas less than 800 kilometres away.



The British label BREEAM® (Building Research Establishment Environmental Assessment Method) is the oldest and most widely used certification system for sustainable building. It focuses primarily on the preservation of biodiversity in the building surroundings. It is considered an internationally recognised measurement of the environmental impact of a building.



The French sustainability certificate HQE® (Haute Qualité Environnementale) is awarded by a French construction industry association (AS-SOHQE). It determines, for example, the environmental compatibility of all materials used at the site.

Valve, electronic flow rate controller and energy monitoring in a single valve

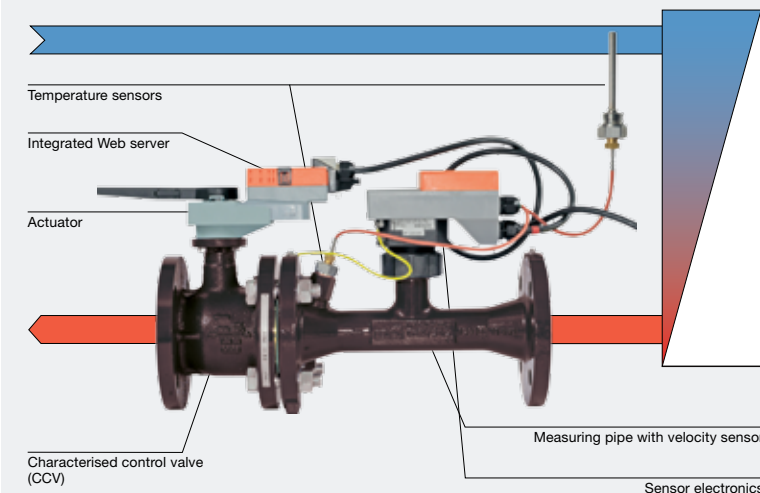

- Efficient regulation of flow and heat exchanger output and monitoring of the Delta T value
- Automated, hydraulic compensation through continuous flow rate measurement
- Energy monitoring via web server and BACnet IP, BACnet MS/TP or MP-Bus®
- Simple system optimisation with the Energy Valve Tool
- Access to data and settings through Internet access
- Temperature range: -10 °C to +120 °C
- 11 nominal diameters from DN15 to DN150

The solution: Belimo Energy Valve™

Heating loop - Cold water circuit	
1	Extraction well Extracts 14°C warm water from a depth of 135 m
2	Absorption well Is used to recirculate the water at a depth of 152 m
3	Dry probes (75 units) Installed at a depth of 100 m, temperature: 12°C
4	Plate heat exchanger
5	Adiabatic chillers (5 units)
6	Electricity produced via solar modules Photovoltaic system, trackers, high terraces

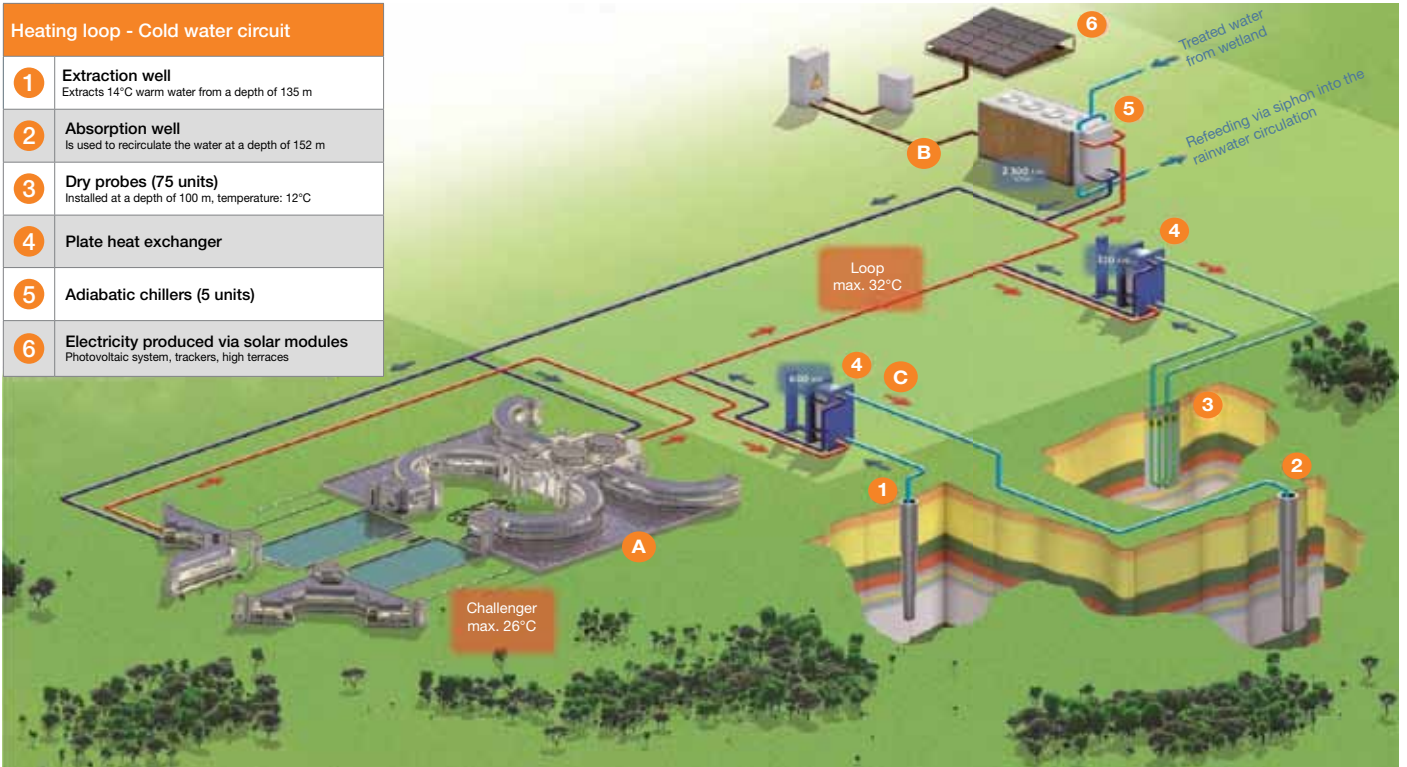

The Challenger site with the application areas of the Belimo Energy Valve™ in the cooling and heating circuit



VRF activation

The VRF system is a reversible air conditioning system with variable control of the refrigerant flow. It combines several units in the building – each comprised of evaporator (cooling) and condenser (heating) with a single exterior unit. The VRF system controls the Belimo Energy Valve™ and thus adjusts the flow in accordance with the load. Energy monitoring enables real-time exchange of all data with the building technology control centre.

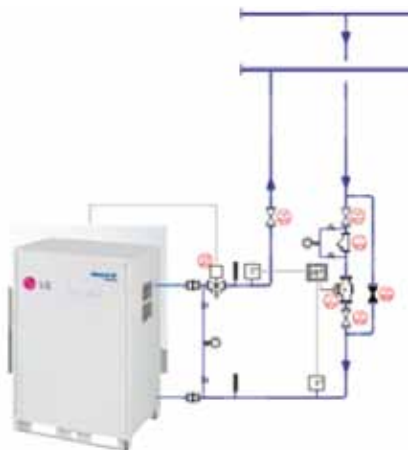

Cooling tower activation

The adiabatic cooling towers are heat exchangers that offer many advantages: By recycling they consume very less water, there is no evaporation of water into the air flow, the water needs no preparation and free-cooling is possible. The towers are controlled by means of a Belimo Energy Valve™ activation via a BACnet IP command.

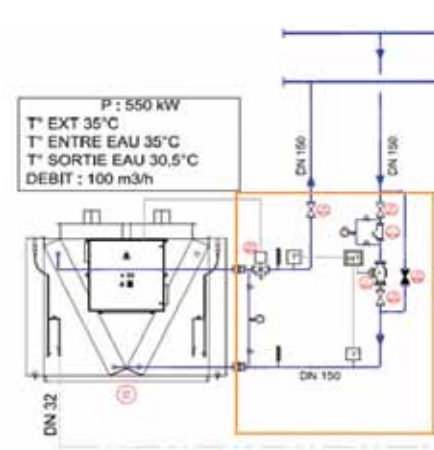

Exchanger activation

The geothermal probes are controlled by means of Energy Valve activation via a BACnet IP command.

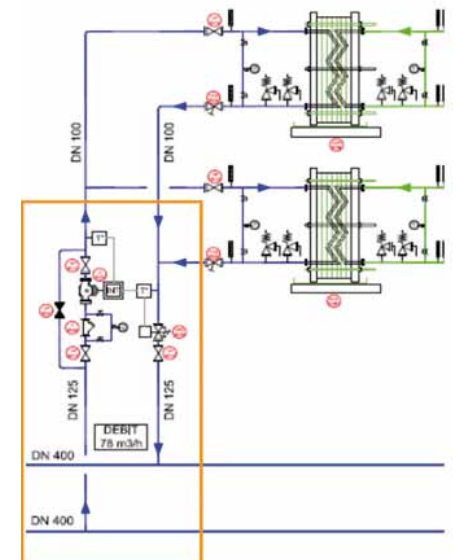

Global player in energy management

Bouygues SA was founded in 1952 and is the fifth-largest European construction company. In addition to its Construction and Real Estate Division, the group also owns media and tele-communications companies. Bouygues Construction is responsible for all building construction and civil engineering projects. The Energy and Services Division has been divested to the 100%-owned subsidiary Bouygues Energies & Services.



As a developer, installer, maintainer and operator of building technology, the service provider has in the meantime become highly specialised in the area of HVAC energy management.

“The Energy Valve provides us with a clear competitive advantage.”

Bouygues Energies & Services was involved early in the renovation project during the planning phase in order to optimise costs over the entire life cycle of the building. Project manager Thierry Hermant (Head of Service, Bouygues Energy & Services) explained in a telephone interview why the Energy Valve from Belimo convinced him from the very beginning: “The Energy Valve gave us the opportunity to propose a good technical solution, which distinguished ourselves from our competitors. It offers clearly more comprehensive possibilities than a conventional 2-way control valve. It enables the building technicians to detect all of the efficiency problems in the system with respect to valves, heat exchangers and Delta T values and to rectify these themselves. Furthermore, the valve is able to secure the flow rate in our cooling circulation system on its own. This makes it a unique solution on the market.”

Energy efficiency through data monitoring

How the Belimo Energy Valve™ helps save energy.

When the water flow rate is increased in a heat exchanger, the energy transfer also rises up to a certain degree of saturation. In the Energy Flow Rate diagram, the level of saturation indicates when the maximum energy transfer rate is achieved under the given situational conditions (water temperature and temperature, humidity and volumetric flow of the air). Generally speaking, in order to save energy, cooling machines and pumps should therefore never be operated in the saturation range. This inefficiency effect can be avoided with the aid of the Energy Valve. The optimum Delta T value is determined with the Energy Valve Tool, set in the valve and permanently monitored. Furthermore, Energy Monitoring enables the analysis of the energy flows of a climate system in the building and thus also a prognosis of future energy consumption.

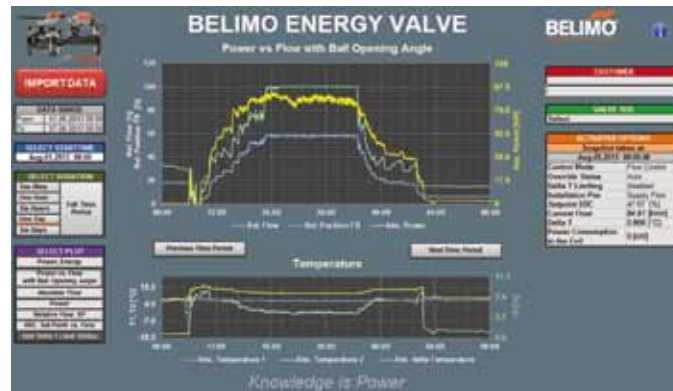

The Belimo Energy Valve Tool enables the import and analysis of all of the data recorded by the Energy Valve. System stability, start-up behaviour, water temperature changes and many other energy-influencing factors can be visualised and optimised in transparent fashion with the Tool.

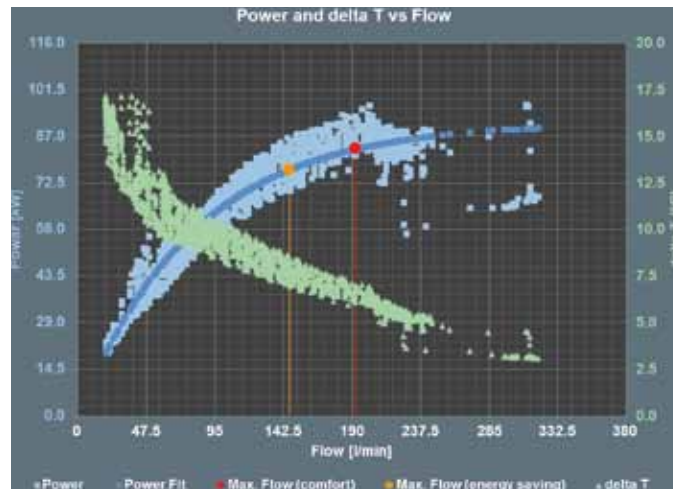

The Energy Valve Tool also makes it possible to depict the heat exchanger characteristic curve and to discern the degree of saturation on the basis of the performance curve (blue). A Delta T minimum value can be set in the valve in order to avoid a situation in which additional water is nonetheless being pumped through the heat exchanger. This control helps to save both energy and costs.

Belimo worldwide: www.belimo.com



5-year guarantee



On site around the globe



Complete product range



Tested quality



Short delivery times



Comprehensive Support

BELIMO Automation AG, Brunnenbachstrasse 1, CH-8340 Hinwil, Switzerland
Tel. +41 (0)43 843 61 11, Fax +41 (0)43 843 62 68, info@belimo.ch

BELIMO[®]