

# NMX24-SR-T Technical Data Sheet

Modulating, Non-Spring Return, 24 V, for DC 2...10 V or 4...20 mA



Technical Data	
Power Supply	24 VAC, ±20%, 50/60 Hz, 24 VDC, ±10%
Power consumption in operation	2.5 W
Power consumption in rest position	0.4 W
Transformer sizing	5 VA (class 2 power source)
Shaft Diameter	1/2...1.05" round, centers on 1/2" and 3/4" with insert, 1.05" without insert
Electrical Connection	Screw terminal (for 26 to 14 GA wire)
Overload Protection	electronic throughout 0...95° rotation
Operating Range	2...10 V, 4...20 mA w/ ZG-R01 (500 Ω, 1/4 W resistor)
Input Impedance	100 kΩ (0.1 mA), 500 Ω
Angle of rotation	Max. 95°, adjustable with mechanical stop
Torque motor	90 in-lb [10 Nm]
Direction of motion motor	selectable with switch 0/1
Position indication	reflective visual indicator (snap on)
Manual override	external push button
Running Time (Motor)	95 s, constant, independent of load
Ambient humidity	max. 95% r.H., non-condensing
Ambient temperature	-22...122°F [-30...50°C]
Storage temperature	-40...176°F [-40...80°C]
Degree of Protection	IP20, NEMA 1, UL Enclosure Type 1
Housing material	UL94-5VA
Agency Listing	cULus acc. to UL60730-1A/-2-14, CAN/CSA E60730-1:02, CE acc. to 2014/30/EU and 2014/35/EU
Noise level, motor	45 dB(A)
Servicing	maintenance-free
Quality Standard	ISO 9001
Weight	1.9 lb [0.9 kg]

**Torque min. 90 in-lb, for control of damper surfaces up to 22 sq. ft.**

## Application

For proportional modulation of dampers in HVAC systems. Actuator sizing should be done in accordance with the damper manufacturer's specifications.

The actuator is mounted directly to a damper shaft up to 1.05" in diameter by means of its universal clamp, 1/2" self centered default. A crank arm and several mounting brackets are available for applications where the actuator cannot be direct coupled to the damper shaft.

The actuator operates in response to a 2 to 10 VDC, or with the addition of a 500 Ω resistor, a 4 to 20 mA control input from an electronic controller or positioner. A 2 to 10 VDC feedback signal is provided for position indication or master-slave applications.

## Operation

The actuator is not provided with and does not require any limit switches, but is electronically protected against overload. The anti-rotation strap supplied with the actuator will prevent lateral movement.

The NMB(X) series provides 95° of rotation and a visual indicator indicates position of the actuator. When reaching the damper or actuator end position, the actuator automatically stops. The gears can be manually disengaged with a button on the actuator cover.

The NMB(X)24-SR... actuators use a sensorless brushless DC motor, which is controlled by an Application Specific Integrated Circuit (ASIC). The ASIC monitors and controls the actuator's rotation and provides a digital rotation sensing (DRS) function to prevent damage to the actuator in a stall condition. Power consumption is reduced in holding mode.

Add-on auxiliary switches or feedback potentiometers are easily fastened directly onto the actuator body for signaling and switching functions.

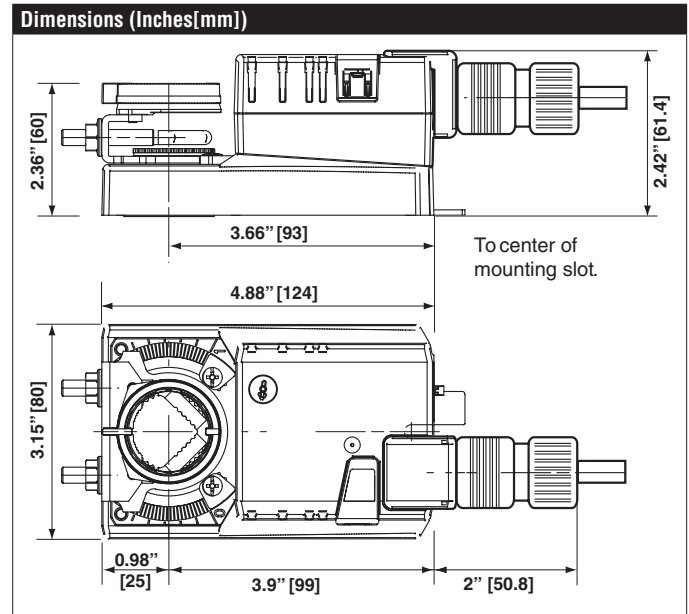







Date created, 02/10/2020 - Subject to change. © Belimo Aircontrols (USA), Inc.

## Typical Specification

Proportional control damper actuators shall be electronic direct-coupled type, which require no crank arm and linkage and be capable of direct mounting to a shaft up to 1.05" diameter. Actuators must provide proportional damper control in response to a 2 to 10 VDC or, with the addition of a 500 Ω resistor, a 4 to 20 mA control input from an electronic controller or positioner.

Actuators shall have brushless DC motor technology and be protected from overload at all angles of rotation. Actuators shall have reversing switch and manual override on the cover. Actuator will be provided with screw terminal strip for electrical connections. Run time shall be constant and independent of torque. A 2 to 10 VDC feedback signal shall be provided for position indication. Actuators shall be cULus listed, have a 5-year warranty, and be manufactured under ISO 9001 International Quality Control Standards. Actuators shall be as manufactured by Belimo.

## Wiring Diagrams

-  Provide overload protection and disconnect as required.
-  Actuators may also be powered by 24 VDC.
-  Only connect common to negative (-) leg of control circuits.
-  A 500 Ω resistor (ZG-R01) converts the 4 to 20 mA control signal to 2 to 10 VDC.
-  Actuators may be connected in parallel if not mechanically linked. Power consumption and input impedance must be observed.
-  Actuators are provided with a numbered screw terminal strip instead of a cable.

