

- Use to control the supply of the fan coil units chilled or hot water to maintain the room temperature.
  - Three type: internal thread 1/2"(15mm), 3/4"(20mm) & 1"(25mm).
  - On/Off type, 2-way normally-closed and 3-way diverting.
  - Use fully-enclosed one-way hysteretic synchronous motor, with spring return and water-proof function.
  - The actuator assembles the valve body quickly and easily without the need for linkages and calibration.
- 籍着控制风机盘管的冷冻或热水供应来维持室内的温度。
  - 三种口径：15mm、20mm 及 25mm。
  - 开关型阀门，有 2 通常闭及 3 通分流型。
  - 使用全封闭单向同步磁滞电机，利用弹簧复位及具有防水功能。
  - 驱动器及阀体可容易及快速地直接装配，不需任何连接及调校。

### SPECIFICATIONS (规格参数)

Model 型号	Dimension 尺寸	Type 规格	Cv factor Cv 值	Kv factor Kv 值	Close-off Pressure 关闭压力 PSI(kPa)	Weight(g) 重量
Z215S	1/2" (15mm)	2-way valve (二通阀)	2.0	1.7	60(414)	700
Z220S	3/4" (20mm)		2.5	2.2	50(344)	850
Z225S	1" (25mm)		3.0	2.6	44(303)	1000
Z315S	1/2" (15mm)	3-way valve (三通阀)	2.5	2.2	60(414)	750
Z320S	3/4" (20mm)		3.0	2.6	50(344)	900
Z325S	1" (25mm)		3.5	3.0	44(303)	1050

### Technical data

Rated power supply 电压	24V /120V / 230V	
Power consumption 功率	6.5 Watts, 7VA	
Connecting cable 电线	10cm long;2x0.75mm <sup>2</sup>	
Operating time 操作时间	-motor 13 to 18sec -spring 4 to 5 sec	
Ambient temperature range 环境温度	0 to 40 °C	
Action 操作	-spring return -port "A" open	
Medium 流体	Chilled or hot water, up to50% Glycol	
Size 尺寸	1/2", 3/4", 1"	
Type of end fitting 连接方式	Internal thread BSP	
Material 材料	Actuator 驱动器	Stainless steel base plate, ABS cover
	Valve body 阀体	Forged Brass
	Valve flap 阀瓣	NBR
Pressure rating 压力范围	300PSI-PN20 (2,100kPa)	
Close-off pressure 关闭压差	44 to 60 PSI (303 to 414kPa)	
Media temperature range 流体温度范围	0 to 93 °C	
Maintenance 保养	Maintenance free	

Model 型号	DIMENSIONS 尺寸 (mm)		
	A	B	C
Z215S	70	23	66
Z220S	87	23	66
Z225S	96	26	66
Z315S	70	31	66
Z320S	87	37	66
Z325S	96	42	66

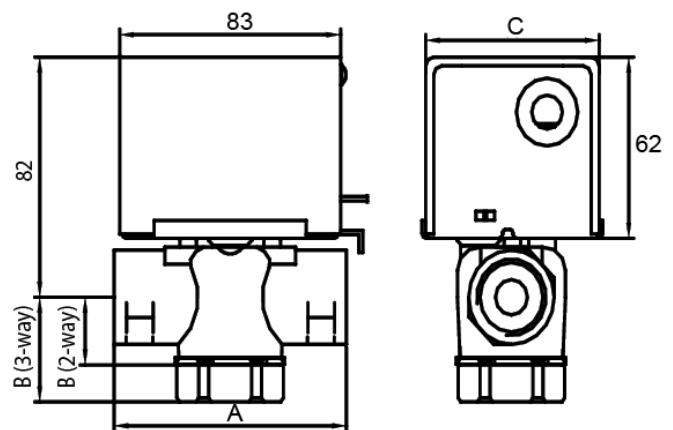

- The flow direction is from “B” to “A”, refer to figure 1.
- When installing the actuator of normal-closed valve, it must be placed in the open condition by manual operating lever.
- The manual operating lever of the actuator will move to the automatic position when the valve is operated first time.
- Z..S Series valves are designed for the application to closed system. Use in open system is not recommended. High levels of dissolved oxygen and chlorine round in open systems may erode the valve material and result in premature failure.

- 流向是由端“B”到端“A”，见图1。
- 当安装常闭型驱动器时，必须先把手动操作杆扳到“开”处。
- 当第一次使用时，手动操作杆会转移至自动位置上。
- Z..S 系列电动阀是为全封闭式系统设计。不建议在开放式系统使用。在开放式系统里，过多的氧气及氯气溶解会侵蚀阀体材料，形成过早的损坏。

## VALVE BODY CONFIGURATION

### 电动阀水管连接图

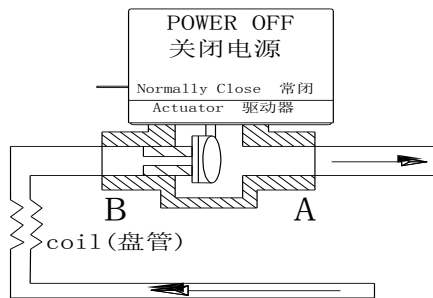

Fig. 1: 2-way Normally Closed to the Coil  
图 1: 二通阀(常闭)管道安装

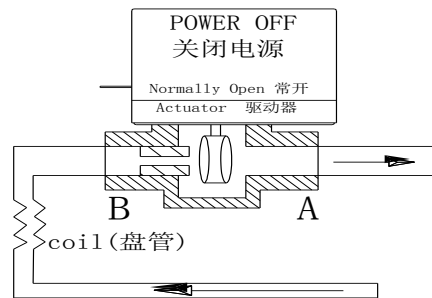

Fig. 2: 2-way Normally Open to the Coil  
图 2: 二通阀(常开)管道安装

3-way is only configured as N.C. to B port  
for N.O. configuration to the coil, simply turn the valve around.  
三通只作与B口常闭布置；若用于常开，将阀移转180°即可。

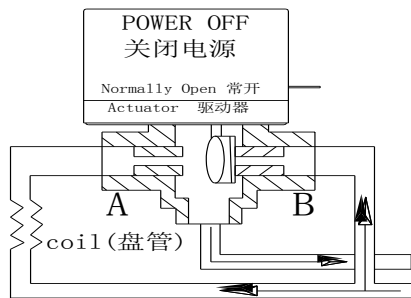

Fig. 3: 3-way valve in Mixing Configuration, Normally Open to coil  
图 3: 三通阀混合布置(常开)管道安装

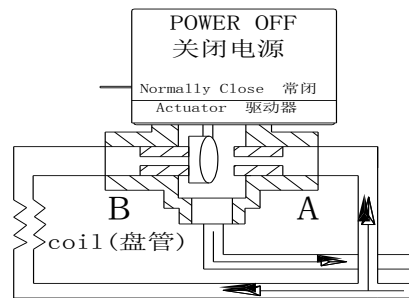

Fig. 4: 3-way valve in Mixing Configuration, Normally Closed to coil  
图 4: 三通阀混合布置(常闭)管道安装

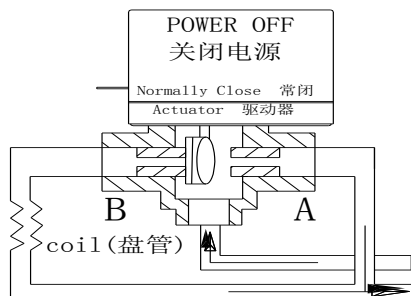

Fig. 5: 3-way valve in Diverting Configuration, Normally Closed to coil  
图 5: 三通阀分流布置(常闭)管道安装

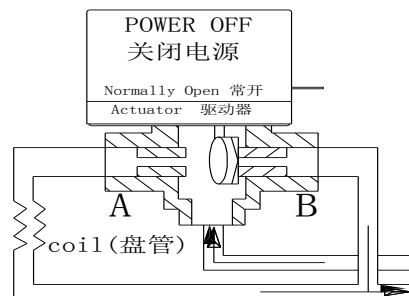

Fig. 6: 3-way valve in Diverting Configuration, Normally Open to coil  
图 6: 三通阀分流布置(常开)管道安装