

Configurable rotary actuator for butterfly valves

- Torque motor Max. 90 Nm
- Nominal voltage AC/DC 24 V
- Control modulating 2...10 V variable
- Position feedback 2...10 V variable
- Running time motor 35 s
- Optimum weather protection for use outdoors



Technical data

Electrical data	Nominal voltage	AC/DC 24 V
	Nominal voltage frequency	50/60 Hz
	Nominal voltage range	AC 19.2...28.8 V / DC 21.6...28.8 V
	Power consumption in operation	9 W
	Power consumption in rest position	3 W
	Power consumption for wire sizing	12 VA
	Connection supply / control	Terminals
	Parallel operation	No
Functional data	Torque motor	Max. 90 Nm (not constant)
	Operating range Y	2...10 V
	Input impedance	100 kΩ
	Operating range Y variable	Start point 0.5...30 V End point 2.5...32 V
	Operating modes optional	Open/close Modulating (DC 0...32 V)
	Position feedback U	2...10 V
	Position feedback U note	Max. 0.5 mA
	Position feedback U variable	Start point 0.5...8 V End point 2.5...10 V
	Position accuracy	±5%
	Manual override	with push-button, can be locked
	Running time motor	35 s / 90°
	Running time motor variable	35...150 s
	Sound power level, motor	45 dB(A)
	Adaptation setting range	manual (automatic on first power-up)
	Adaptation setting range variable	No action Adaptation when switched on Adaptation after pushing the manual override button
	Override control	MAX (maximum position) = 100% MIN (minimum position) = 0% ZS (intermediate position, AC only) = 50%
Override control variable	MAX = (MIN + 33%)...100% MIN = 0%...(MAX - 33%) ZS = MIN...MAX	
Position indication	Mechanical, integrated	
Safety data	Protection class IEC/EN	III, Safety Extra-Low Voltage (SELV)

Technical data

Safety data	Power source UL	Class 2 Supply
	Degree of protection IEC/EN	IP66/67
	Degree of protection NEMA/UL	NEMA 4X
	Housing	UL Enclosure Type 4X
	EMC	CE according to 2014/30/EU
	Certification IEC/EN	IEC/EN 60730-1 and IEC/EN 60730-2-14
	Type of action	Type 1
	Rated impulse voltage supply / control	0.8 kV
	Pollution degree	4
	Ambient humidity	Max. 95% RH, non-condensing
	Ambient temperature	-30...50°C [-22...122°F]
	Storage temperature	-40...80°C [-40...176°F]
	Servicing	maintenance-free
Mechanical data	Connection flange	F05
	Weight	Weight
		5.5 kg

Safety notes

- This device has been designed for use in stationary heating, ventilation and air-conditioning systems and must not be used outside the specified field of application, especially in aircraft or in any other airborne means of transport.
- Only authorised specialists may carry out installation. All applicable legal or institutional installation regulations must be complied with during installation.
- Junction boxes must at least correspond with housing IP degree of protection!
- The cover of the protective housing may be opened for adjustment and servicing. When it is closed afterwards, the housing must seal tight (see installation instructions).
- The switch for changing the direction of rotation may only be operated by authorised specialists. The direction of rotation must not in particular be reversed in a frost protection circuit.
- The angle of rotation is not permitted to be subjected to mechanical limitation. It is forbidden to alter the mechanical end stops.
- The device may only be opened at the manufacturer's site. It does not contain any parts that can be replaced or repaired by the user.
- The device contains electrical and electronic components and must not be disposed of as household refuse. All locally valid regulations and requirements must be observed.
- The device is not designed for applications where chemical influences (gases, fluids) are present or for utilisation in corrosive environments in general.
- The actuator may not be used in plenary applications (e.g. suspended ceilings or raised floors).
- The materials used may be subject to external influences (temperature, pressure, construction fastening, effect of chemical substances, etc.), which cannot be simulated in laboratory tests or field trials. In case of doubt, we definitely recommend that you carry out a test. This information does not imply any legal entitlement. Belimo will not be held liable and will provide no warranty.
- If cables which are not authorised for UL (NEMA) Type 4X applications are used, then flexible metallic cable conduits or suitable threaded cable conduits of equal value are to be used.

Product features

- Fields of application** The actuator is particularly suitable for utilisation in outdoor applications and is protected against the following weather conditions:
- UV radiation
 - Rain / Snow
 - Dirt / Dust
 - Air humidity
 - Alternating climate / frequent and severe temperature fluctuations (Recommendation: use the actuator with integrated factory-installed heating which can be ordered separately to prevent internal condensation)
- Simple direct mounting** Simple direct mounting on the butterfly valve. The mounting orientation in relation to the butterfly valve can be selected in 90° (angle) increments.
- Manual override** Manual override with push-button possible (the gear train is disengaged for as long as the button is pressed or remains locked).
The housing cover must be removed for manual override.
- High functional reliability** The actuator is overload protected, requires no limit switches and automatically stops when the end stop is reached.
- Torque not constant** Due to the non-linear torque characteristic the actuator can only be used for butterfly valves and not for other armatures.

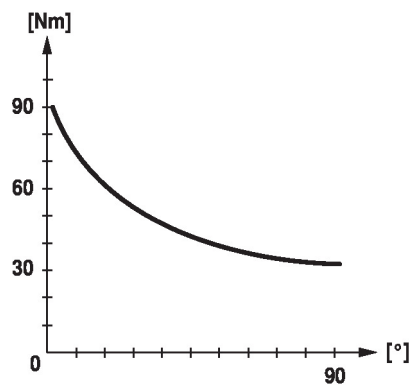
Accessories

Electrical accessories	Description	Type
	Auxiliary switch 1x SPDT add-on	S1A
	Auxiliary switch 2x SPDT add-on	S2A
	Feedback potentiometer 140 Ω add-on	P140A
	Feedback potentiometer 1 kΩ add-on	P1000A
	Feedback potentiometer 10 kΩ add-on	P10000A
	Heater, with mechanical humidistat	HH24-MG
	Heater, with adjustable thermostat	HT24-MG
Options ex works only	Description	Type
	Heater, with adjustable thermostat	HT24-MG
	Heater, with mechanical humidistat	HH24-MG

Electrical installation

Supply from isolating transformer.
Direction of rotation switch is covered. Factory setting: Direction of rotation Y2.

Electrical installation

AC/DC 24 V, modulating

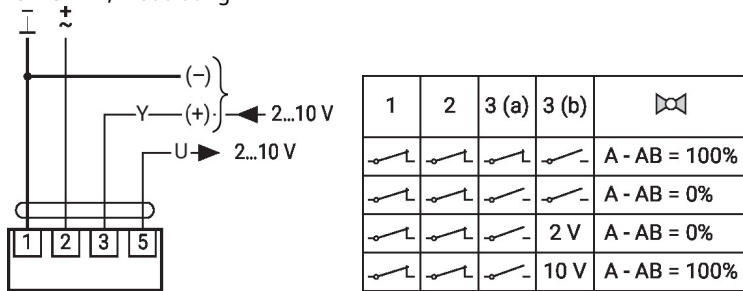

Further electrical installations

Functions with basic values (conventional mode)

Override control with AC 24 V with relay contacts

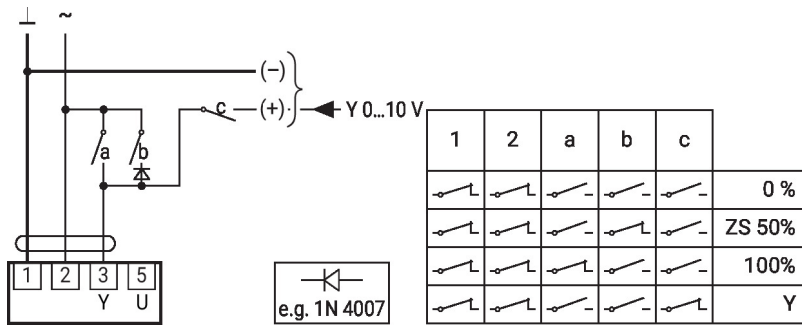

Override control with AC 24 V with rotary switch

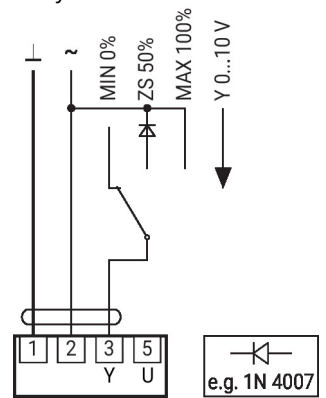

Control remotely 0...100% with positioner SG..

Minimum limit with positioner SG..

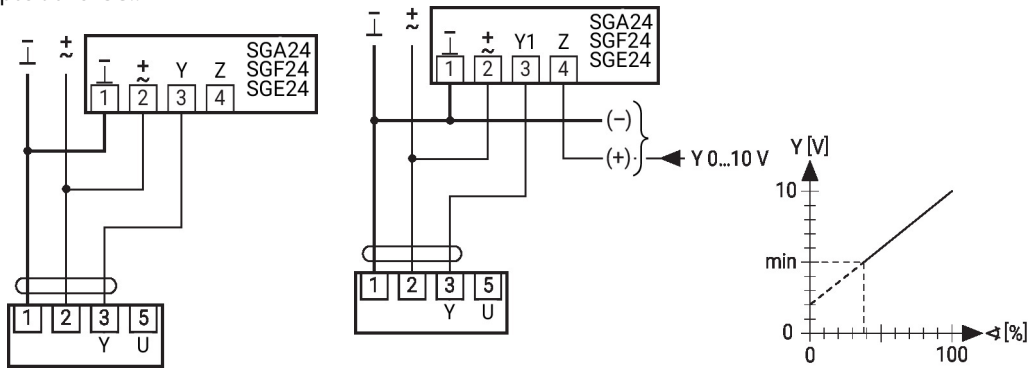

Primary/secondary operation (position-dependent)

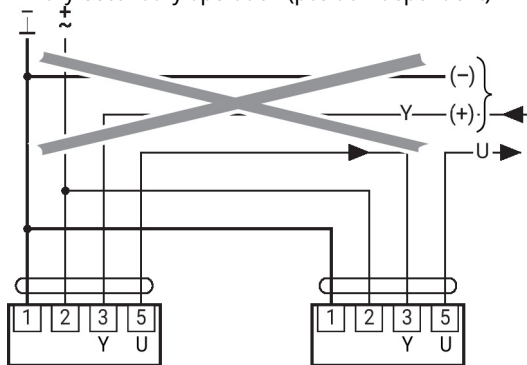

Further electrical installations

Functions with basic values (conventional mode)

Control with 4...20 mA via external resistor

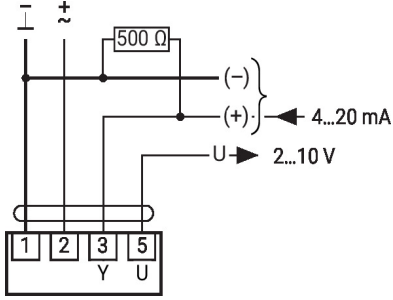

Caution:

The operating range must be set to DC 2...10 V.
The 500 Ohm resistor converts the 4...20 mA current signal to a voltage signal DC 2...10 V.

Functional check

Procedure

1. Connect 24 V to connections 1 and 2
2. Disconnect connection 3:
 - with direction of rotation L: Actuator rotates to the left
 - with direction of rotation R: Actuator rotates to the right
3. Short-circuit connections 2 and 3:
 - Actuator runs in opposite direction

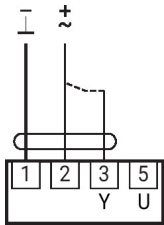

Functions with specific parameters (Parametrisation necessary)

Override control and limiting with AC 24 V with relay contacts

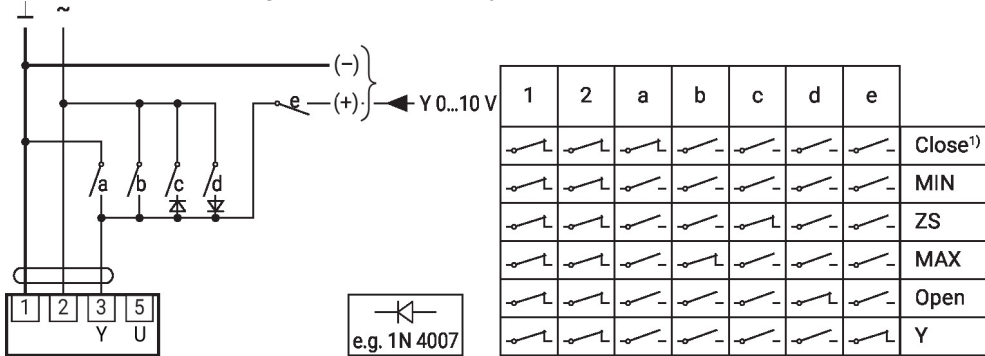

Control open/close

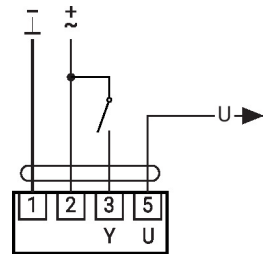

Override control and limiting with AC 24 V with rotary switch

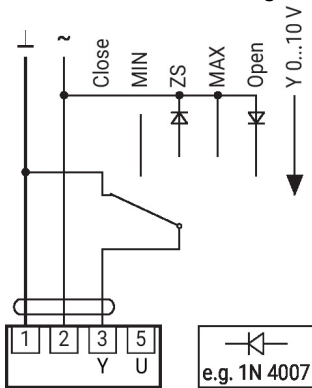

Caution:

The "Close" function is only guaranteed if the start point of the operating range is defined as min. 0.5 V.

Operating controls and indicators

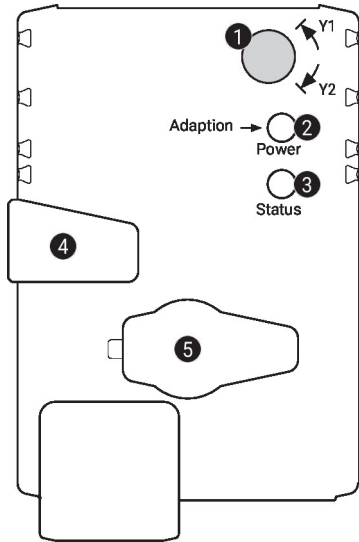

1 Direction of rotation switch

Switch over: Direction of rotation changes

2 Push-button and LED display green

Off: No power supply or malfunction
 On: In operation
 Press button: Triggers angle of rotation adaptation, followed by standard mode

3 Push-button and LED display yellow

Off: Standard mode
 On: Adaptation or synchronisation process active
 Press button: No function

4 Manual override button

Press button: Gear train disengages, motor stops, manual override possible
 Release button: Gear train engages, standard mode

5 Service plug

For connecting parametrisation and service tools

Check power supply connection

2 Off and **3** On Possible wiring error in power supply

Service

Wired connection The device can be parametrised by ZTH EU via the service socket.
 For an extended parametrisation, Belimo Assistant 2 can be connected.

Connection ZTH EU / Belimo Assistant 2

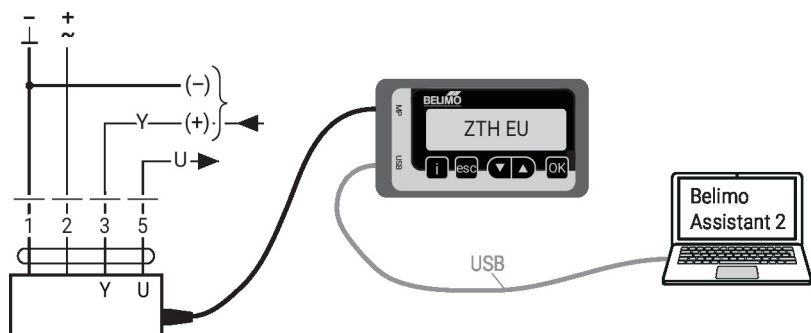

Dimensions

