

Configurable rotary actuator for butterfly valves

- Torque motor 2000 Nm
- Nominal voltage AC 230 V
- Control modulating 2...10 V variable
- Position feedback 2...10 V variable
- With 2 integrated auxiliary switches
- with torque limit protection and alarm



Picture may differ from product

Technical data

Electrical data	Nominal voltage	AC 230 V
	Nominal voltage frequency	50/60 Hz
	Nominal voltage range	AC 207...253 V
	Power consumption in operation	246 W
	Power consumption in operation note	incl. heater
	Power consumption for wire sizing	276 VA
	Current consumption	1.2 A
	Auxiliary switch	2x SPDT, 1x 3° / 1x 87°
	Switching capacity auxiliary switch	1 mA...5 A (3 A inductive), DC 5 V...AC 250 V
	Connection supply / control	Terminals 2.5 mm ² (Wire 2x 1.5 mm ² or 1x 2.5 mm ²)
Parallel operation	Yes (note the performance data)	
Functional data	Torque motor	2000 Nm
	Operating range Y	2...10 V
	Input impedance	100 kΩ
	Operating range Y variable	Start point 0.5...30 V End point 2.5...32 V
	Position feedback U	2...10 V
	Position feedback U note	Max. 0.5 mA
	Position feedback U variable	Start point 0.5...8 V End point 2.5...10 V
	Position accuracy	±5%
	Manual override	temporary with handwheel (non-rotating)
	Angle of rotation	90°
	Angle of rotation note	Internal limit switch, not adjustable
	Running time motor	70 s / 90°
	Sound power level, motor	70 dB(A)
	Duty cycle value	50% (= active time 70 s / operating time 140 s)
Position indication	Mechanical, integrated	
Safety data	Protection class IEC/EN	I, protective earth (PE)
	Protection class auxiliary switch IEC/EN	I, protective earth (PE)
	Degree of protection IEC/EN	IP67
	Type of action	Type 1
	Pollution degree	4
	Ambient humidity	Max. 95% RH, non-condensing

Technical data

Safety data	Ambient temperature	-30...65°C [-22...149°F]
	Storage temperature	-30...80°C [-22...176°F]
	Servicing	maintenance-free
Mechanical data	Connection flange	F16
Weight	Weight	69 kg
Materials	Housing material	Die cast aluminium

Safety notes

- This device has been designed for use in stationary heating, ventilation and air-conditioning systems and must not be used outside the specified field of application, especially in aircraft or in any other airborne means of transport.
- Caution: Mains voltage!
- Only authorised specialists may carry out installation. All applicable legal or institutional installation regulations must be complied with during installation.
- The device does not contain any parts that can be replaced or repaired by the user.
- The device contains electrical and electronic components and must not be disposed of as household refuse. All locally valid regulations and requirements must be observed.
- Warning: Leakage current possible (<3.5 mA)! When connecting the actuator, connect the earth first and then the supply connections! Do not disconnect the earth until after both supply connections have been disconnected!
- A change of the preset angle of rotation limitation may not take place neither by means of limit switches nor by means of PC-Tool/ZTH... .
- Outdoor application: only possible in case that no (sea) water, snow, ice, insolation or aggressive gases interfere directly with the device and that it is ensured that the ambient conditions remain within the thresholds according to the data sheet at any time.

Product features

Fields of application	The actuator is particularly suitable for utilisation in outdoor applications and is protected against the following weather conditions: - UV radiation - Dirt / Dust - Rain / Snow - Air humidity
Operating mode	The actuator is connected with a standard control signal and drives to the position defined by the control signal. The measuring voltage U serves for the electrical display of the actuator position 0...100% and as control signal for other actuators.
Internal heating	An internal heater prevents condensation buildup.
Configurable device	The factory settings cover the most common applications. Input and output signals and other parameters can be altered with the Belimo service tool MFT-P.
Simple direct mounting	Simple direct mounting on the butterfly valve. The mounting orientation in relation to the butterfly valve can be selected in 90° (angle) increments.
Mounting on Belimo valves	Refer to the valve documentation for suitable valves, their permitted fluid temperatures and close-off pressures.
Manual override	The butterfly valve can be closed (turn clockwise) and opened (turn counterclockwise) with the handwheel. The handwheel does not move while the motor is running.

Product features

- High functional reliability** Mechanical end stops limit the actuator to -2° and 92° . The internal limit switches interrupt the voltage supply to the motor. In addition, a motor thermostat provides overload protection and interrupts the voltage supply if the actuator is used outside of the specified temperatures.
- Signalling** The integrated auxiliary switches are equipped with a gold/silver coating that permits integration both in circuits with low currents (mA range) and in ones with larger-sized currents (A range) in accordance with the specifications in the data sheet. It should be noted with this application however that the contacts can no longer be used in the milliampere range after larger currents have been applied to them, even if this has taken place only once.
- Torque not constant** A torque limit switch is equipped to protect the system from structural overloads. The torque limit is carefully adjusted at the factory and it is not adjustable. If the valve is outside the recommended operating condition or when the valve is stuck, the torque limit switch interrupts the voltage supply to protect the system. An alarm switch will be triggered when the torque limit switch is activated.

Accessories

Tools	Description	Type
	Service tool, with ZIP-USB function, for configurable and communicative Belimo actuators, VAV controller and HVAC performance devices	ZTH EU
	Connecting cable 5 m, A+B: RJ12 6/6	ZK6-GEN
	Belimo PC-Tool, Software for adjustments and diagnostics	MFT-P
	Service tool for wired and wireless setup, on-site operation and troubleshooting.	Belimo Assistant 2

Electrical installation



Caution: Mains voltage!

4-lead connection

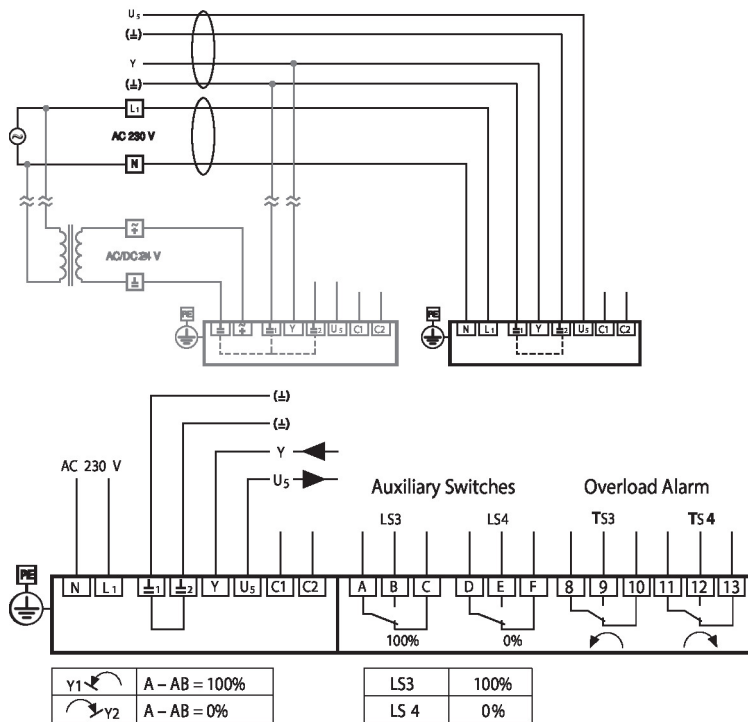

Connection and function elements

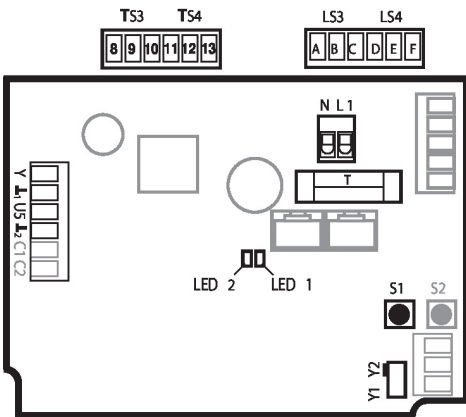

N / L1	Power supply voltage	
Y1	Direction of rotation switch	Actuator rotates anticlockwise (ccw), valve opens
Y2	Direction of rotation switch	Actuator rotates clockwise (cw), valve closes
Y	Control signal	Actuator remains at its last position when Y-signal is lost
U5	Position feedback	
L1 / L2	Ground 24 V-side	
S1	Adaptation button	Adaptation procedure is started (press S1 for 3s) Adaptation must take place after the TC1/TC2 have been adjusted
S2	Not used	
LED 1 (yellow)	On	Adaptation procedure activated
	Of	Standard operation
LED 2 (green)	On	In operation
	Of	No voltage supply or fault
T	Plug-in fuse	Type T10A250V
LS3	Auxiliary switch	Factory setting 87°
LS4	Auxiliary switch	Factory setting 3°
C1 / C2	Not used	
TS3	Overload alarm	Terminal #8 will loop to terminal #9 if torque value overloads
TS4	Overload alarm	Terminal #11 will loop to terminal #12 if torque value overloads

Settings



Limit switches TC1/TC2 and angle of rotation limitation are provided with sealing varnish and may not be adjusted.

Setting cam

The setting cams for limit and auxiliary switches can be accessed by removing the housing cover.

Optionally, auxiliary switches LS4 / LS3 can be connected for signalling.

Limit switches LS2 / LS1 interrupt the voltage to the motor and are controlled by setting cams TC...

The setting cams turn with the spindle. The butterfly valve closes when the spindle is turning clockwise (cw) and opens when the spindle is turning counterclockwise (ccw).

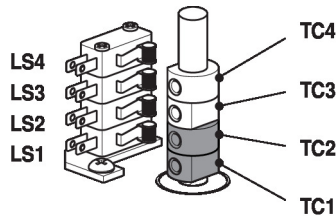

TC1/TC2 with sealing varnish: limit switches are secured against adjustment

Settings of setting cams TC..

- TC4 for auxiliary switch position closed (factory setting 3°).
- TC3 for auxiliary switch position open (factory setting 87°).
- TC2 for limit switch closed (0°).
- TC1 for limit switch open (90°).

Settings

Adjusting setting cams

- 1) Use a 2.5 mm Allen key to unscrew the corresponding setting cams TC..
- 2) Turn the setting cam using the Allen key
- 3) Set as shown in the illustration below
- 4) Use the Allen key to tighten the corresponding setting cams

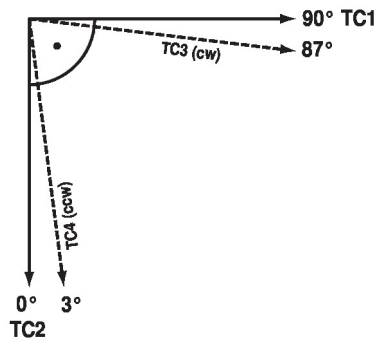

TC1: OPEN
 TC2: CLOSED
 TC3: Present position
 TC4: Desired position

Mechanical angle-of-rotation limitation

The mechanical angle of rotation (3) is set at the factory to -2° and 92° and cannot be changed.

The handwheel is rotated by means of a worm gear in a planetary gear unit. The gearing is stopped mechanically by means of two setscrews (3).

Relationship between mechanical angle of rotation limitation, limit and auxiliary switches

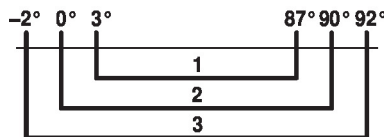

- 1: Auxiliary switch adjustable TC3 / TC4
- 2: Limit switch fix adjusted TC1 / TC2
- 3: Mechanical angle of rotation fix adjusted

- 3: Angle of rotation limitation with sealing varnish: Must not be adjusted
- 4: Connection handwheel

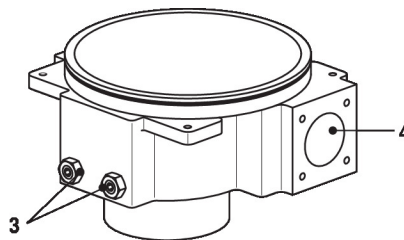

Service



Notes

Actuators may be configured with Belimo PC-Tool MFT-P or ZTH EU service tool using the service socket of the actuator.

Service

Wired connection Local connection with ZTH EU via service socket of the SY actuator.

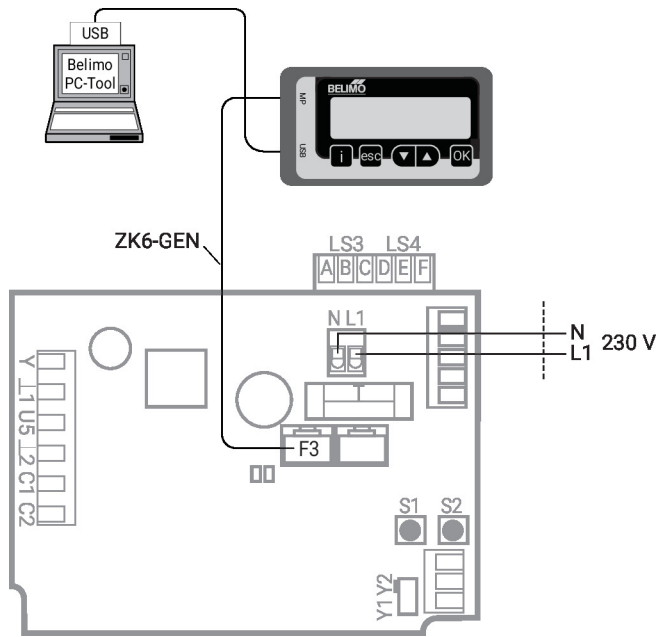

Note

The housing cover must be opened so that the connections are accessible.

Dimensions

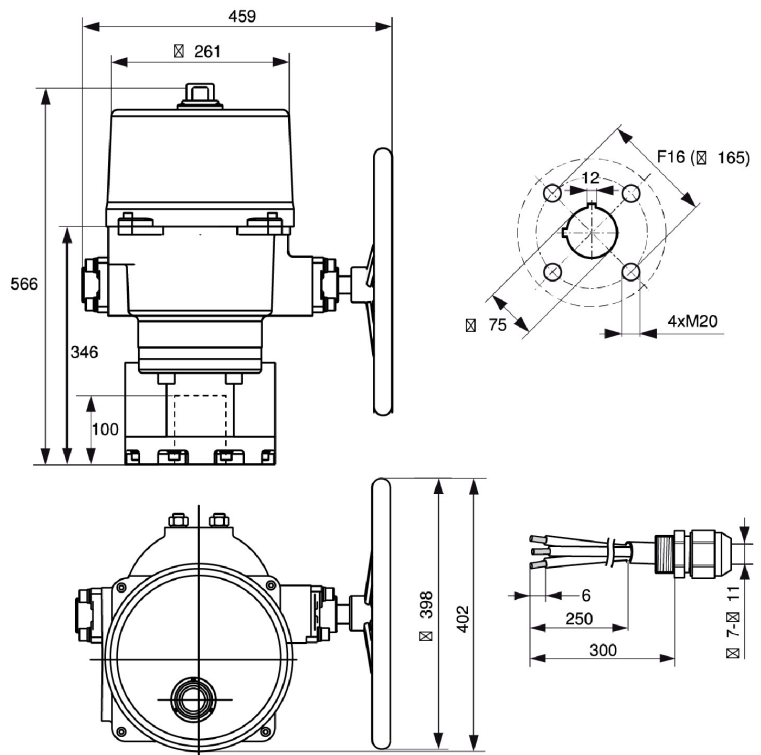

Further documentation

- Data sheets for butterfly valves
- Installation instructions for actuators and/or butterfly valves
- Notes for project planning for butterfly valves
- Quick Guide – Belimo Assistant 2