

Ball Valve (VS), DN 3/4" [20], 2-way, Cv 51



2-year warranty



Picture may differ from product

**Type overview**

<b>Type</b>	<b>DN</b>
B220VS	3/4" [20]

**Technical data**

<b>Functional data</b>	Valve size [mm]	0.75" [20]
	Fluid	chilled or hot water, up to 60% glycol, steam
	Fluid Temp Range (water)	-22...280°F [-30...138°C]
	Body Pressure Rating	600 psig WOG psi
	Close-off pressure Δps	600 psi
	Flow characteristic	modified equal percentage
	Leakage rate	ANSI Class VI
	Pipe connection	Internal thread NPT (female)
	Max Differential Pressure (Steam)	35 psi
	Flow Pattern	2-way
	Controllable flow range	90° rotation
	Cv	51
	Maximum Inlet Pressure (Steam)	35 psi [241 kPa]
	<b>Materials</b>	Valve body
Housing seal		PTFE
Stem		316 stainless steel
Stem seal		RPTFE
Seat		RPTFE
Lock nut		stainless steel
Retainer		B16 Brass
Ball		316 stainless steel
<b>Suitable actuators</b>	Non Fail-Safe	NMB(X) GRCB(X) GRB(X)
	Spring	NF

**Safety notes**

- **WARNING:** This product can expose you to lead which is known to the State of California to cause cancer and reproductive harm. For more information go to [www.p65warnings.ca.gov](http://www.p65warnings.ca.gov)

Product features

**Application** This valve is typically used in air handling units on heating or cooling coils, and fan coil unit heating or cooling coils. Some other common applications include Unit Ventilators, VAV Box re-heat coils and bypass loops. This valve is suitable for use in a hydronic system with variable flow.

This valve is designed with MFT functionality which facilitates the use of various control input.

Up to 35 psi steam

1/2" - 2" 600 PSIG WOG, Cold Non-Shock

Federal Specification: WW-V-35C, Type II

Composition: BZ

Style: 3

Flow/Mounting details

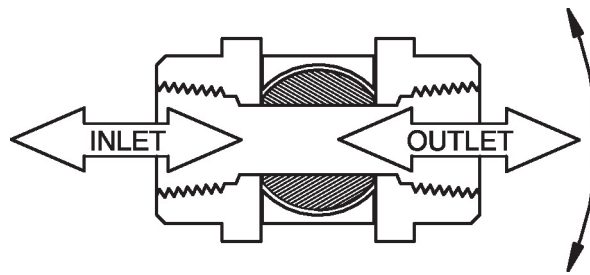

Dimensions

Type	DN	Weight
B220VS	3/4" [20]	1.8 lb [0.80 kg]

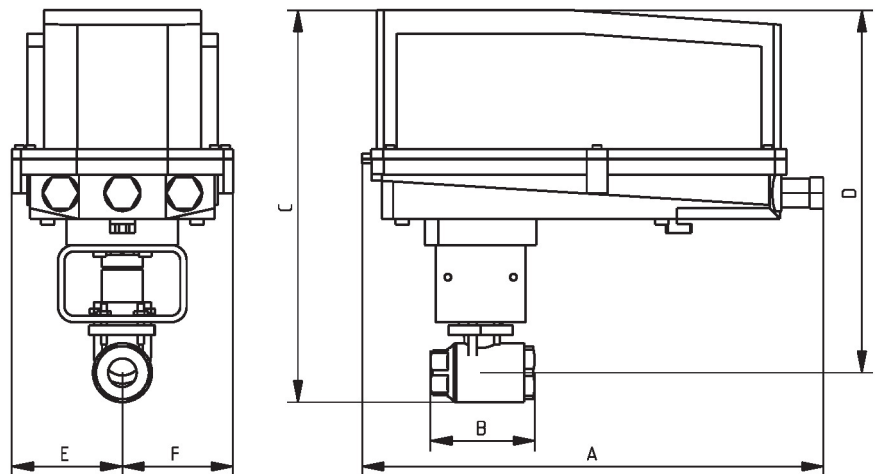

B220VS+GRC..N4

A	B	C	D	E	F
14.1" [358]	3.2" [82]	12.0" [305]	11.1" [282]	3.4" [86]	3.4" [86]