

- Nominal voltage AC/DC 24 V
- Control communicative
- Communication via BACnet MS/TP, Modbus RTU, Belimo-MP-Bus or conventional control
- Conversion of active sensor signals and switching contacts

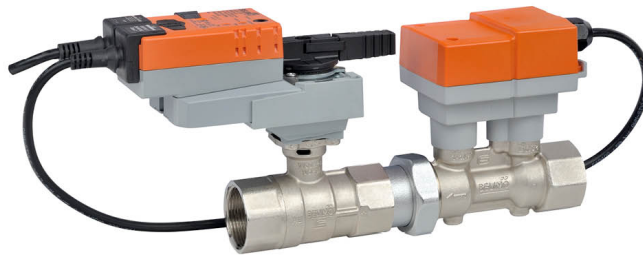

5-year warranty



Technical data

Electrical data	Nominal voltage	AC/DC 24 V
	Nominal voltage frequency	50/60 Hz
	Power consumption in operation	4.5 W
Data bus communication	Communicative control	BACnet MS/TP MP-Bus Modbus RTU
	Number of nodes	Max. 32 (without repeater)
Functional data	Valve size [mm]	1.25" [32]
	Operating range Y	2...10 V
	Operating range Y note	Hybrid via 2...10 V
	Input Impedance	100 kΩ (0.1 mA), 500 Ω
	Options positioning signal	VDC variable
	Position feedback U	2...10 V
	Position feedback U variable	VDC variable
	Running Time (Motor)	90 s
	Sound power level Motor	35 dB(A)
	Control accuracy	±5%
	Min. controllable flow	1% of V ^{nom}
	Fluid	chilled or hot water, up to 60% glycol max (open loop/steam not allowed)
	Fluid Temp Range (water)	14...250°F [-10...120°C]
	Close-off pressure Δps	200 psi
	Differential Pressure Range	5...50 psi or 1...50 psi see flow reductions chart in tech doc
	Flow characteristic	equal percentage or linear
	Body Pressure Rating	360 psi
	GPM	28.5
	Servicing	maintenance-free
Manual override	external push button	
Flow measurement	Measuring accuracy flow	±2%*
	Measurement Repeatability	±0.5% (Flow)
	Sensor Technology	Ultrasonic with glycol and temperature compensation
Safety data	Degree of protection IEC/EN	IP54
	Degree of protection NEMA/UL	NEMA 2

Safety data	Enclosure	UL Enclosure Type 2
	Agency Listing	cULus acc. to UL60730-1A/-2-14, CAN/CSA E60730-1:02, CE acc. to 2014/30/EU and 2014/35/EU; Listed to UL 2043 - suitable for use in air plenums per Section 300.22(c) of the NEC and Section 602.2 of the IMC
	Quality Standard	ISO 9001
	Ambient temperature	-22...122°F [-30...50°C]
	Storage temperature	-40...176°F [-40...80°C]
	Ambient humidity	Max. 95% RH, non-condensing
Materials	Valve body	Nickel-plated brass body
	Flow measuring pipe	brass body nickel-plated
	Spindle	stainless steel
	Spindle seal	EPDM (lubricated)
	Characterized disc	stainless steel TEFZEL®
	Seat	PTFE
	Pipe connection	NPT female ends
	O-ring	EPDM
	Ball	stainless steel

Safety notes

- This device has been designed for use in stationary heating, ventilation and air-conditioning systems and must not be used outside the specified field of application, especially in aircraft or in any other airborne means of transport.
- Outdoor application: only possible in case that no (sea) water, snow, ice, insulation or aggressive gases interfere directly with the actuator and that is ensured that the ambient conditions remain at any time within the thresholds according to the data sheet.
- Only authorized specialists may carry out installation. All applicable legal or institutional installation regulations must be complied during installation.
- The device contains electrical and electronic components and must not be disposed of as household refuse. All locally valid regulations and requirements must be observed.
- **WARNING:** This product can expose you to lead which is known to the State of California to cause cancer and reproductive harm. For more information go to www.p65warnings.ca.gov

Product features

Flow measurement *All flow tolerances are at 68°F [20°C] & water.

Accessories

Electrical accessories	Description	Type
	Replacement flow sensor for EPIV, Ultrasonic 1 1/4" 32	M2432-EP
	Service Tool, with ZIP-USB function, for programmable and communicative Belimo actuators, VAV controller and HVAC performance devices	ZTH US
Mechanical accessories	Description	Type
	Weather shield for Belimo Energy Valve™, 25...50, Ultrasonic models only	ZS-EPIV-EV-50-SCNF

Electrical installation

BACnet MS/TP / Modbus RTU

Cable colors:

- 1= black
 - 2 = red
 - 3 = white
 - 5 = orange
 - 6 = pink
 - 7 = grey
- BACnet / Modbus signal assignment:
 C1 = D- = A
 C2 = D+ = B

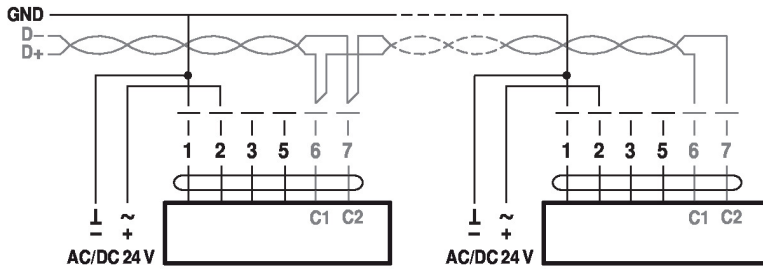

Connection with active sensor, e.g. 0...10 V @ 0...50°C

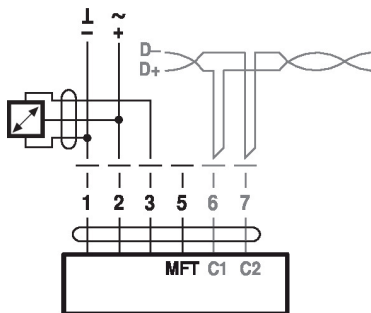

Possible voltage range:
 0...32 V (resolution 30 mV)

Connection with switching contact, e.g. Δp monitor

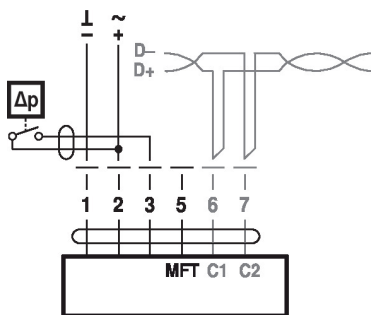

Requirements for switching contact:
 The switching contact must be able to accurately switch a current of 16 mA @ 24 V.

Modbus RTU / BACnet MS/TP with analogue setpoint (hybrid mode)

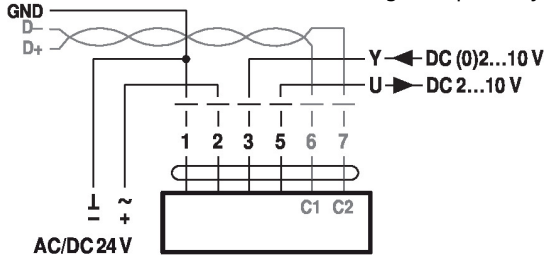

Operation on the MP-Bus

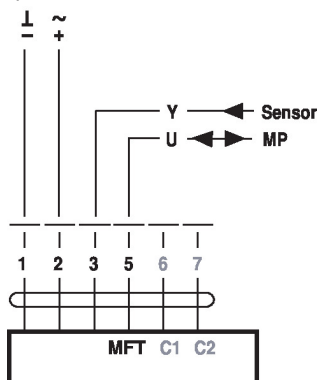

Dimensions

Dimensional drawings

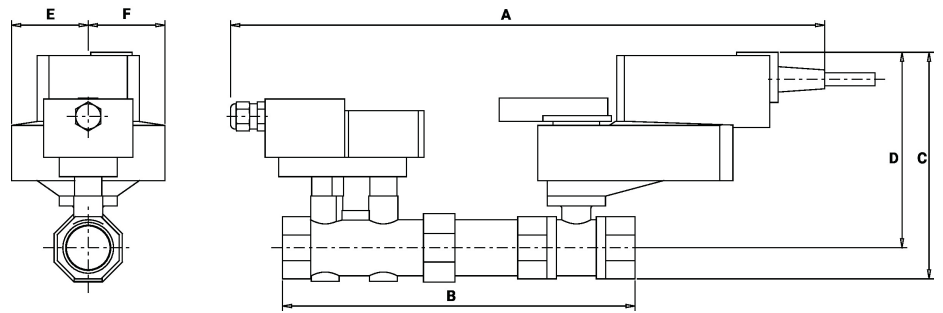

A	B	C	D	E	F
16.4" [416]	10.0" [254]	6.1" [154]	5.2" [131]	2.0" [51]	2.0" [51]