

### INTRODUCTION

The room temperature sensor series is a single gang, blank stainless steel wall plate that incorporates a precision temperature sensor used to monitor room temperature.

### BEFORE INSTALLATION

Read these instructions carefully before installing and commissioning the temperature sensor. Failure to follow these instructions may result in product damage. Do not use in an explosive or hazardous environment, with combustible or flammable gases, as a safety or emergency stop device or in any other application where failure of the product could result in personal injury. **Take electrostatic discharge precautions during installation and do not exceed the device ratings.**

### MOUNTING

The plate sensor installs directly on a standard electrical box and should be mounted five feet from the floor of the area to be controlled. Do not mount the sensor near doors, opening windows, supply air diffusers or other known air disturbances. Avoid areas where the sensor is exposed to vibrations or rapid temperature changes.

Before mounting the enclosure, first complete the wiring instructions outlined below.

### WIRING

- Use 18-24 AWG shielded wiring for all connections. Do not locate the device wires in the same conduit with wiring used to supply inductive loads such as motors. Make all connections in accordance with national and local codes.
- Pull at least six inches of wire into the enclosure, then complete the wiring connection according to the wiring diagrams below.
- The plate sensor is a 2 wire hook up and is not polarity sensitive. See Figure 1.
- All connections should be made using either butt-splices or soldering. The use of wire nuts is not recommended.

Once wiring is complete, secure the plate to the junction box using the supplied mounting screws as shown in Figure 2.

### SPECIFICATION:

Sensor Type..... 10,000  $\Omega$  Type 2, NTC Thermistor  
 Accuracy.....  $\pm 0.2^{\circ}\text{C}$  ( $\pm 0.36^{\circ}\text{F}$ ) @  $25^{\circ}\text{C}$  ( $77^{\circ}\text{F}$ )  
 Temperature Range.....  $-20$  to  $60^{\circ}\text{C}$  ( $-4$  to  $140^{\circ}\text{F}$ )  
 Enclosure ..... Stainless steel - IP50 (NEMA 1)  
 Termination..... Pigtail (2-wire)  
 Dimensions..... 115 mm L x 70.6 mm W x 4.3 mm D  
 (4.53" x 2.78" x 0.17")  
 Country of Origin..... Canada

### TYPICAL WIRE RESISTANCE VALUES

When using low resistance sensors, long wire runs can add significant error to the readings. Use the following chart to determine errors due to wire resistance or consider using a transmitter for better accuracy. Locate the type of wire being used. Multiply the total length of the wire (distance from the controller to the sensor and back) by the number found in the chart below for total resistance.

GAUGE WIRE TYPE	18 AWG	22 AWG	24 AWG
STRANDED (OHMS/FOOT)	5.85 m $\Omega$	14.75 m $\Omega$	23.29 m $\Omega$
SOLID (OHMS/FOOT)	6.4 m $\Omega$	15.85 m $\Omega$	25.72 m $\Omega$

### DIMENSIONS

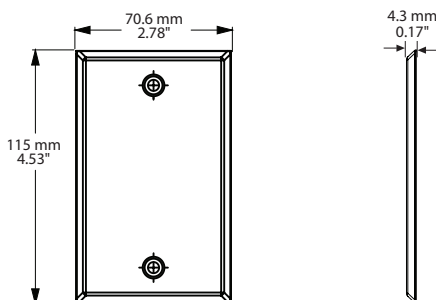

Figure 1

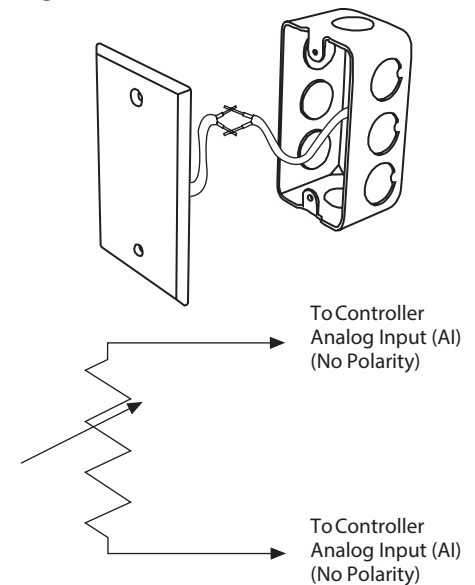

Figure 2

